

## Energy Analyzer

# UMG 96-S2

## User Manual and Technical Data

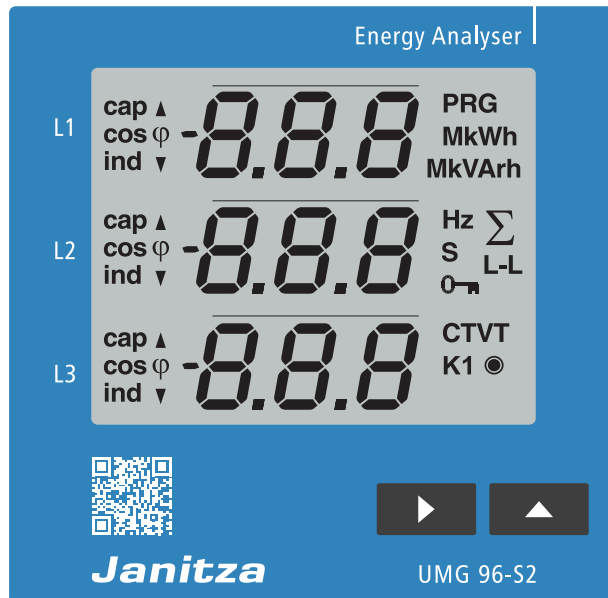

## UMG 96-S2

### Measurement device for recording energy measured values

Doc. no.: 2.062.019.0.1

Status: 04/2023

The German version is the  
original version of the documentation

### Subject to technical changes.

The content of our documentation has been compiled with the utmost care and is based on the latest information available to us. Nevertheless, we would like to point out that the updating of this document cannot always be performed simultaneously with the further technical development of our products. Information and specifications can be changed at any time.

Please consult [www.janitza.com](http://www.janitza.com) for information on the current version.

## Table of contents

1.	General information . . . . .	8
1.1	Disclaimer . . . . .	8
1.2	Copyright notice . . . . .	8
1.3	Technical changes . . . . .	8
1.4	About this user manual . . . . .	8
1.5	Defective device/disposal. . . . .	8
2.	Safety . . . . .	10
2.1	Presentation of warning notices and safety instructions . . . . .	10
2.2	Danger levels . . . . .	10
2.3	Product safety. . . . .	10
2.4	Dangers when handling the device . . . . .	10
2.5	Electrically qualified personnel . . . . .	11
2.6	Warranty in the event of damage . . . . .	11
2.7	Product description . . . . .	12
2.8	Device description . . . . .	12
2.9	Incoming goods inspection . . . . .	12
2.10	Intended use . . . . .	12
2.11	Device characteristics. . . . .	13
2.12	Device functions . . . . .	13
2.13	Performance features . . . . .	13
2.14	EC declaration of conformity . . . . .	14
2.15	Scope of delivery . . . . .	14
2.16	Available accessories . . . . .	14
2.17	Measurement method. . . . .	14
2.18	Operating concept . . . . .	14
2.19	GridVis network analysis software . . . . .	14
2.20	Overview of range of functions . . . . .	15
	2.20.1 Configuration on the device (via 2 keys) . . . . .	15
	2.20.2 Communication . . . . .	15
	2.20.3 Digital output . . . . .	15
	2.20.4 Measured values . . . . .	15
3.	Design of the device . . . . .	16
3.1	Front view - display . . . . .	16
3.2	Rear view - location of the connections . . . . .	17
3.3	Labeling of the device - rating plate . . . . .	18
4.	Assembly. . . . .	19
4.1	Installation location . . . . .	19
4.2	Installation position . . . . .	19
4.3	Fastening . . . . .	19
5.	Network systems . . . . .	20

6.	Installation . . . . .	20
6.1	Rated voltages . . . . .	20
6.1.1	Three-phase 4-conductor network with grounded neutral conductor . . .	20
6.2	Disconnectors . . . . .	21
6.3	Supply voltage . . . . .	21
6.4	Voltage measurement . . . . .	22
6.4.1	Voltage swell . . . . .	22
6.4.2	Mains frequency . . . . .	23
6.4.3	Voltage measurement connection versions . . . . .	23
6.5	Current measurement . . . . .	24
6.5.1	Current measurement connection versions . . . . .	24
6.5.2	Summation current measurement . . . . .	25
6.5.3	Ammeter . . . . .	25
7.	Connection . . . . .	26
7.1	Connection to a PC . . . . .	26
7.2	RS485 interface (serial interface) . . . . .	27
7.3	Shielding . . . . .	28
7.4	Termination resistors . . . . .	28
7.5	Bus structure . . . . .	29
8.	Communication via the RS485 interface with the Modbus RTU protocol . . . . .	30
9.	Digital output . . . . .	31
9.1	Pulse output function . . . . .	31
9.2	Pulse output connection example . . . . .	31
9.3	Pulse value (parameter address 102) . . . . .	31
9.4	Pulse length (parameter address 106) and pulse pause . . . . .	32
9.5	Determining the pulse value . . . . .	32
10.	Operation and button functions . . . . .	33
10.1	Operation . . . . .	33
10.2	Button functions . . . . .	34
10.3	Parameter (addresses) and measured value display . . . . .	35
10.3.1	Parameter (addresses) . . . . .	35
10.3.2	“Parameter address” example display . . . . .	35
10.3.3	Measured value display . . . . .	35
10.3.4	Example of measured value display . . . . .	35
11.	Configuration . . . . .	36
11.1	Connecting the supply voltage . . . . .	36
11.2	Programming mode . . . . .	36
11.3	Password protection . . . . .	36
11.4	Current transformer and voltage transformer . . . . .	36

11.5	Programming the current transformer . . . . .	37
11.6	Programming the voltage transformer . . . . .	37
11.7	Programming the parameters . . . . .	38
11.7.1	Setting the device address (parameter address 000) . . . . .	38
11.7.2	Setting the baud rate (parameter address 001) . . . . .	38
11.7.3	Mean values and averaging times (parameter address 040, 041 and 042) . . . . .	38
11.7.4	Deleting min. and max. values (parameter address 506) . . . . .	39
11.7.5	Measured value display, automatic display change and changeover time (parameter address 037, 038, 039) . . . . .	39
11.7.6	User password (parameter address 050) . . . . .	39
11.7.7	Deleting the energy counter (parameter address 507) . . . . .	40
11.7.8	LCD contrast (parameter address 035) . . . . .	40
11.7.9	Serial number (parameter address 911). . . . .	40
11.7.10	Software release (parameter address 913) . . . . .	41
11.8	Important information for configuration . . . . .	41
11.8.1	Energy counter . . . . .	41
11.8.2	Reading the active energy. . . . .	41
11.8.3	Harmonics and harmonics content . . . . .	41
11.8.4	Phase sequence. . . . .	42
11.8.5	Operating hours counter . . . . .	42
11.8.6	Backlight . . . . .	43
12.	Commissioning . . . . .	44
12.1	Connecting the supply voltage . . . . .	44
12.2	Connecting the measured voltage . . . . .	44
12.3	Connecting the measured current . . . . .	44
12.4	Checking the phase sequence . . . . .	44
12.5	Checking the phase assignment . . . . .	44
12.6	Checking the power measurement . . . . .	44
12.7	Checking the measurement. . . . .	44
12.8	Checking the individual powers. . . . .	45
12.9	Checking the sum powers . . . . .	45
13.	Measured value display and automatic display change profile . . . . .	46
13.1	Measured value displays . . . . .	46
13.2	Automatic display change profile . . . . .	46
13.3	Select measured value display profiles in the GridVis® software . . . . .	46
13.4	Overview of measured value displays - display profile 1-3 . . . . .	48
13.5	Overview of automatic display change profiles 1-3. . . . .	52
14.	Connection example . . . . .	54

15.	Service and maintenance . . . . .	56
15.1	Repair and calibration. . . . .	56
15.2	Front film and display . . . . .	56
15.3	Device adjustment . . . . .	56
15.4	Firmware update . . . . .	56
15.5	Service . . . . .	56
16.	Error messages . . . . .	57
16.1	Warnings . . . . .	57
16.2	Serious errors . . . . .	57
16.3	Internal error cause recognition. . . . .	57
16.4	Exceeding the measurement range. . . . .	58
16.5	Measurement range exceedance parameter . . . . .	58
16.6	Procedure in the event of errors . . . . .	59
17.	Technical data . . . . .	60
17.1	Function characteristics. . . . .	62
17.2	Parameter and Modbus address list . . . . .	64
17.3	Table 1 - Parameter list . . . . .	64
17.4	Table 2 - Modbus address list (excerpt of the frequently required measured values). . . . .	65
17.5	Number formats. . . . .	66
17.6	Note on saving measured values and configuration data . . . . .	66
18.	Dimensional drawings . . . . .	67

## 1. General information

### 1.1 Disclaimer

It is essential that the information products for the devices are observed to ensure safe operation and achieve the specified performance characteristics and product features.

Janitza electronics GmbH assumes no liability for personal injuries, property damage and financial losses resulting from the failure to observe the information products.

Make sure that your information products are legible and accessible.

### 1.2 Copyright notice

© 2018 - Janitza electronics GmbH - Lahnau.  
All rights reserved.

Any duplication, processing, distribution and any other kind of use, even in part, is prohibited.

All trademarks and any resulting rights belong to the respective holders of these rights.

### 1.3 Technical changes

- Make sure that the user manual matches your device.
- First, make sure you have read and understood the document accompanying the product.
- Keep the documents accompanying the product accessible through its service life and hand them over to the subsequent owner where applicable.
- Refer to [www.janitza.com](http://www.janitza.com) for information concerning device revisions and the associated adjustments to the documentation accompanying the product.

### 1.4 About this user manual

Please send us any questions, comments or suggestions for improvement about the user manual via e-mail to [info@janitza.com](mailto:info@janitza.com).

### 1.5 Defective device/disposal

Send **defective devices** back to the manufacturer for inspection (complete with accessories). Do not attempt to independently open or repair the device since otherwise the warranty claim will expire!

Please observe the national regulations for the **disposal!** Dispose of individual parts, where necessary, depending on the properties and existing country-specific regulations, e.g. as:

- Electronic waste
- Batteries and accumulators
- Plastic
- Metal

or commission a certified disposal company with the scrapping.

Please also observe the information in chapter „16. Service and maintenance“ on page 56.





## 2. Safety

The safety chapter contain notes that must be observed for your personal safety and to prevent property damage.

### 2.1 Presentation of warning notices and safety instructions

The warning notices listed below

- can be found in the complete documentation.
- can be found on the devices themselves.
- point out potential risks and dangers.
- confirm information which clarifies or simplifies procedures.





The additional symbol on the device itself indicates an electrical danger that can result in serious injuries or death.



The general warning symbol calls attention to possible risks of injury. Observe all the instructions listed under this symbol in order to prevent injuries or even death.

### 2.2 Danger levels

Warning notices and safety instructions are highlighted by a warning symbol and the danger levels are presented as follows depending on the level of risk:

 <b>DANGER</b>
Indicates an imminently dangerous situation that will result in serious or fatal injuries in the event of noncompliance.
 <b>WARNING</b>
Indicates an imminently dangerous situation that can result in serious or fatal injuries in the event of noncompliance.
 <b>CAUTION</b>
Indicates an imminently dangerous situation that can result in minor injuries in the event of noncompliance.
<b>ATTENTION</b>
Indicates an imminently dangerous situation that can result in property damage or environmental damage in the event of noncompliance.
<b>NOTE</b>
Points out procedures during which a danger of injuries or property damage does <b>not</b> exist.

### 2.3 Product safety

The device corresponds to the state of the art and complies with the generally accepted safety rules; nevertheless, dangers may arise.

Observe the safety requirements and warning notices. Failure to observe the notices can result in personal injury and/or damage to the product.

Any impermissible modification or use of this device

- exceeding the specified mechanical, electrical or other operating limits can result in personal injury and/or damage to the product.
- applies as "misuse" and/or "negligence" with respect to the product warranty and thus voids the warranty for coverage of potentially resulting damages.

Read and understand the user manual before installation, operation, maintenance and use of the device.

Only operate the device in flawless condition in compliance with this user manual and the accompanying documents. Send defective devices back to the manufacturer taking into consideration the transport conditions. Keep the user manual through the entire service life of the device and always have it readily available for reference.

Also observe the applicable legal and safety requirements for your system for the respective application when using the device.

### 2.4 Dangers when handling the device

When operating electrical devices, specific parts of these devices can carry dangerous voltage. Therefore, property damage and personal injuries up to death can occur if they are not handled correctly.

Therefore, when handling our devices, always observe the following:

- Do not exceed the threshold values stated in the user manual and on the rating plate; this must also be observed during inspection and commissioning.
- Observe the safety instructions and warning notices in all documents that accompany the devices.

### **WARNING**

#### **Risk of injury due to electric voltage!**

Serious personal injuries or death may occur!

Therefore, please observe the following:

- Before starting work on your system, disconnect the system from the power supply! Secure it against being switched back on! Determine that there is no current! Ground and short-circuit! Cover or block off neighboring parts that are under voltage!
- Also make sure to check the surrounding area for dangerous voltage and switch it off if necessary during the operation and troubleshooting (especially with top hat rail devices)!
- For work on electrical systems, wear protective clothing and safety equipment according to applicable directives!
- Before connection, ground the device/ components at the ground wire connection, if available!
- Do not touch exposed or stripped cores that are under voltage! Fit wire end ferrules on the conductors made of individual wires!
- Dangerous voltages may be present in all circuit parts connected to the voltage supply.
- Secure the supply voltage with a suitable circuit breaker/fuse!
- Never switch off, dismantle or manipulate safety devices!
- There may still be dangerous voltages present in the device or in the components even after disconnection of the supply voltage (capacitor storage).
- Do not operate equipment with open current transformer circuits.
- Only connect screw-type terminals with the same numbers of poles and same type!
- Do not exceed the threshold values stated in the user manual and on the rating plate; this must also be observed during inspection and commissioning.
- Safety instructions and warning notices in the documents that accompany the devices and their components!

## 2.5 Electrically qualified personnel

To prevent personal injuries and property damage, only electrically qualified personnel may work on the devices and their components, assemblies, systems and circuits. They must also have knowledge

- of the national and international accident prevention regulations.
- of safety technology standards.
- in installation, commissioning, operation, enabling, grounding and labeling of electrical equipment.
- of the requirements for personal protective equipment.

Electrically qualified personnel, in terms of the safety-related notes in all documents accompanying the device and its components, are persons who can prove a professional qualification as an electrician.

### **WARNING**

#### **Warning against impermissible manipulations or improper use of the device or its components!**

Opening, dismantling or impermissible manipulation of the device and its components, which exceeds the specified mechanical, electrical or other operating limits, can result in property damage or injuries up to death.

- Only electrically qualified personnel may work on the devices and their components, assemblies, systems and circuits!
- Always use your device or components as described in the associated documentation.
- Send the device or components back to the manufacturer in the event of visible damage!

## 2.6 Warranty in the event of damage

Any impermissible manipulation or use of the device applies as "misuse" and/or "negligence" with respect to the product warranty and thus voids the warranty for coverage of potentially resulting damages. Observe chap. „3.3 Intended use“ on page 12 for this.

## 2.7 Product description

### 2.8 Device description

The device is intended for:

- measurement and calculation of electric values such as voltage, current, power, energy, harmonics in the building installation, on distributors, circuit breakers and busbar trunking systems.
- measurement of measured voltages and currents which originate from the same network.
- measurements in low-voltage networks with rated voltages up to 300 V conductor to ground and surge voltages of overvoltage category III.
- The measurement in medium and high-voltage networks generally takes place via current and voltage transformers.
- installation in permanently installed switch cabinets or small installation distributors. The installation position is thereby discretionary.
- measurement in medium and high-voltage networks with current and voltage transformers.
- suitable for use in residential and industrial sectors.
- current measurement via external  $\dots/1$  A or  $\dots/5$  A current transformer.

The measurement results can be displayed and can be read out and further processed via the interface of the device.

#### **ATTENTION**

##### **Malfunction or damage to the device due to improper connection.**

Improperly connected devices can deliver incorrect measured values or damage the device.

##### **Please observe the following:**

- The measured voltages and measured currents originate from the same network.
- Do not use the device to measure DC current!
- Ground conductive switchboards!

### 2.9 Incoming goods inspection

The prerequisites for smooth and safe operation of this device and its components include proper transport, storage, setup and assembly, operation and maintenance, as well as observance of the safety instructions and warning notices.

Exercise caution when unpacking and packing the device, without using force and only using suitable tools.

Please check

- the device through a visual inspection to ensure a flawless mechanical condition.
- the scope of delivery for completeness before beginning the installation of the device.

If it can be assumed that a safe operation of the device is no longer possible

- immediately disconnect the device from operation.
- secure the device against being switched back on.

It can be assumed that a safe operation is no longer possible, when, for example, the device:

- has visible damage.
- no longer functions despite an intact power supply.
- was subjected to extended periods of unfavorable conditions (e.g. storage outside of the permissible climate thresholds without adjustment to the room climate, condensation, etc.) or transport stress (e.g. falling from an elevated position, even without visible external damage, etc.).

### 2.10 Intended use

The device is:

- intended for installation in switching cabinets and small installation distributors.
- not intended for installation in vehicles! Using the device in mobile equipment is considered an unusual environmental condition and is only permissible by special agreement.
- not intended for installation in areas exposed to harmful oils, acids, gases, vapors, dust and radiation, etc.

The prerequisites for smooth and safe operation of the device include proper transport, storage, assembly, installation, operation and maintenance.

For Janitza measurement devices and components, use **only** current transformers intended for measuring purposes (“transformers”)!

“Transformers”, unlike “protection transformers”, go into saturation at high current peaks. “Protection transformers” do not have this saturation behavior and can therefore significantly exceed the rated values in the secondary circuit. This can overload the current measurement inputs of the measurement devices!

Furthermore, please note that Janitza measurement devices and components are **not** to be used for critical switching, control or protection applications (protective relays)! Also observe the safety and warning information in the "Installation" chapter!

### 2.11 Device characteristics

Installation depth: 45 mm

230 V supply voltage:

90 V - 265 V (50/60 Hz) or

DC 90 V - 250 V; 300 V CATIII

Frequency range: 45 - 65 Hz

### 2.12 Device functions

- 3 voltage measurements, 230/400 V, 300 V CAT III
- 3 current measurements (via current transformer)
- RS485 interface
- 1 digital output

### 2.13 Performance features

#### General information

- Integrated front panel unit with the dimensions 96 x 96 mm.
- Connection via pluggable screw terminals.
- Operation via 2 keys.
- Password protection
- 3 voltage measurement inputs (300V CATIII).
- 3 current measurement inputs for current transformer.
- RS485 interface (Modbus RTU, slave, up to 38.4 kbps).
- 1 digital output (electrically isolated).

#### Measurement uncertainty

- Active energy, measurement uncertainty class 0.5S for ../5A transformer.
- Active energy, measurement uncertainty class 1 for ../1A transformer.
- Reactive energy, class 1.

## ⚠ WARNING

**Disregarding the connection conditions of the Janitza measurement devices or their components can lead to injuries and even death or to material damage!**

- Do not use Janitza measurement devices or components for critical switching, control or protection applications where the safety of persons and property depends on this function.
- Do not carry out switching operations with the Janitza measurement devices or components without prior inspection by your plant manager with specialist knowledge! In particular, the safety of persons, material assets and the applicable standards must be taken into account!

#### Measurement

- Measurement in TN and TT networks
- Measurement in networks with rated voltages up to L-L 400 V and L-N 230 V.
- Current metering range 0.005 .. 6 Arms
- True effective value measurement (TRMS)
- Continuous scanning of the voltage and current measurement inputs.
- Frequency range of the mains frequency 45 Hz .. 65 Hz.
- Measurement of harmonics 1st through 15th for  $U_{LN}$  and I.
- $U_{LN}$ , I, P (consumption/export), Q (ind./cap.).
- Recording of more than 800 measured values.
- Fourier analysis 1st to 15th harmonics for U and I.
  - 2 rates (switchover via Modbus).

### 2.14 EC declaration of conformity

The EC declaration of conformity and the accompanying CE mark indicates that Janitza electronics GmbH has manufactured the device according to the directives and standards which apply for the device.

The laws, standards and directives applied for the devices by Janitza electronics GmbH can be found in the EC declaration of conformity at [www.janitza.com](http://www.janitza.com).

### 2.15 Scope of delivery

Number	Item no.	Designation
1	52 34 002	UMG 96-S2
1	33 03 372	Installation instructions DE/EN
1	33 03 371	GridVis® software quick start DE/EN
1	33 03 342	Safety instructions
1	52 34 250	Accessories pack

### 2.16 Available accessories

Number	Item no.	Designation
1	29 01 065	Silicone seal, 96 x 96 mm
2	52 22 251	Mounting brackets (screw clamps)
1	15 06 107	Interface converter RS485 <-> USB
1	15 06 015	Interface converter RS485 <-> RS232
1	52 00 008	RS485 termination resistor, 120 Ω

### 2.17 Measurement method

The device measures

- seamlessly and calculates all effective values via a 10/12 period interval.
- the true effective value (TRMS) of the voltages and currents generated at the measurement inputs.

### 2.18 Operating concept

There are several options for programming the device or reading out measured values, e.g. via

- 2 keys on the device.
- the GridVis® software.
- the RS485 interface with the Modbus protocol. Data can be changed and called up with the Modbus address list (excerpt in chap. 18.2 on page 64 or as a download at [www.janitza.com](http://www.janitza.com)).

This user manual only describes the operation of the device via the 2 keys. The GridVis® software has its own "Online help".

### 2.19 GridVis network analysis software

The perfect tool for programming and reading out measurement data is available to you with the GridVis® software (download at [www.janitza.com](http://www.janitza.com)).

#### Performance features of the GridVis® software

- Programming the device.
- Graphic presentation of the measured values.

#### Connection to the PC

Connections for the communication between the PC and device can be found in chap. „8. Connection“ on page 26.

## 2.20 Overview of range of functions

### 2.20.1 Configuration on the device (via 2 keys)

- Password protection (exclusively configurable on the device)
- Primary / secondary current transformer (1...5 selectable)
- Primary / secondary voltage transformer
- Parameter and Modbus addresses, e.g.:
  - Baud rate (RS485 interface)
  - Data frame (stop bits / parity)
  - Pulse value
  - Pulse pause
  - Pulse output: Active, apparent or reactive energy
  - LCD contrast

### 2.20.2 Communication

- Modbus RTU protocol (RS485 interface).
- Firmware update via RS485 interface.

### 2.20.3 Digital output

- 1 digital output (S0 interface) for outputting the active energy, reactive energy or apparent energy obtained.  
Specify the pulse capability and pulse pause for configuration.

### 2.20.4 Measured values

Value	Phase 1..3	Total	Current	Maximum	Minimum	Average	Maximum of the average (max. mean value)
Voltages L-N	✓		✓	✓	✓	✓	
Outer conductor voltages L-L	✓		✓	✓	✓	✓	
Current	✓	calculates N current	✓	✓		✓	✓
Active power	✓	✓	✓	✓		✓	✓
Reactive power	✓	✓	✓	✓		✓	
Active power (mains frequency)	✓	✓	✓	✓		✓	✓
Apparent power	✓	✓	✓	✓		✓	✓
Frequency		✓	✓	✓	✓	✓	
Rotation field			✓				
Phase angle	✓		✓				
Power factor	✓	✓	✓				
THD U (harmonics content)	✓		✓	✓	✓	✓	
THD I (harmonics content)	✓		✓	✓	✓	✓	
Harmonic U 1..15 (odd)	✓		✓	✓			
Harmonic I 1..15 (odd)	✓		✓	✓			
Active energy (obtained)	✓	✓	✓				
Active energy (supplied)	✓	✓	✓				
Reactive energy (inductive)	✓	✓	✓				
Reactive energy (capacitive)	✓	✓	✓				
Apparent energy	✓	✓	✓				
Operating hours counter			✓				
Rates			✓				

Tab. Overview of the measured values that are recorded by the device.  
More information on the measured values can be found in chap. „18.1 Function characteristics“ on page 62.

### 3. Design of the device

#### 3.1 Front view - display

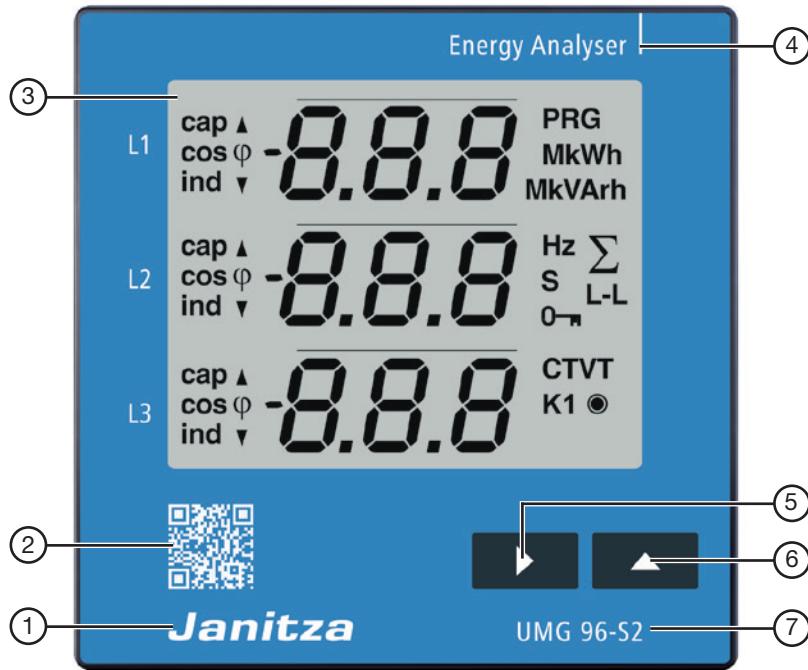

Fig. Front view of UMG 96-S2

Pos.	Designation	Description
1	Manufacturer logo	Logo of the device manufacturer
2	QR code	Coded figure of the device web site from the manufacturer
3	Device display	See chap. „11. Operation and button functions“ on page 33
4	Device type	
5	Key 1	See chap. „11. Operation and button functions“ on page 33
6	Key 2	See chap. „11. Operation and button functions“ on page 33
7	Device designation	



### 3.2 Rear view - location of the connections

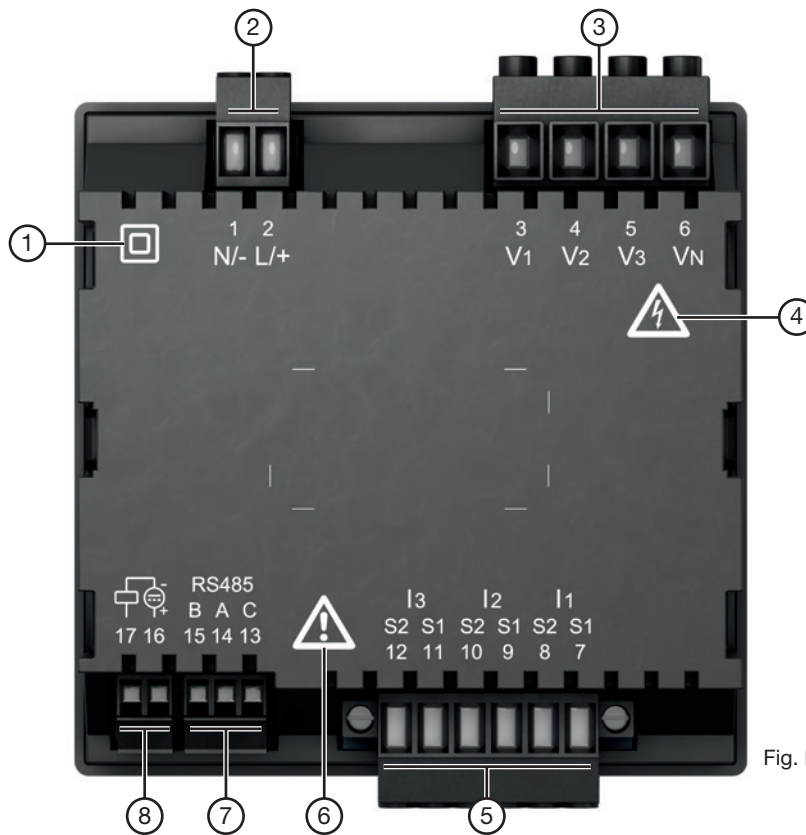

Fig. Rear view of UMG 96-S2

Pos.	Designation	Description
1	“Protection class” symbol	Protection class II (reinforced or double insulation) in accordance with IEC 60536 (VDE 0106, Part 1).
2	“Supply voltage” connection	L/+ and N/-.
3	“Voltage measurement inputs” connection	V1 to V3 (and connection VN).
4	“Danger sign” symbol	Warning symbol that indicates an electrical danger. Observe the warning notices depicted on the device and listed in the documents in order to prevent injuries or even death.
5	“Current measurement inputs” connection	I1 to I3.
6	“Danger sign” symbol	General warning symbol. Observe the warning notices depicted on the device and listed in the documents in order to prevent injuries or even death.
7	“RS485 interface” connection	See chap. „8.2 RS485 interface (serial interface)“ on page 27.
8	“Digital output” connection	See chap. „10. Digital output“ on page 31.

### 3.3 Labeling of the device - rating plate

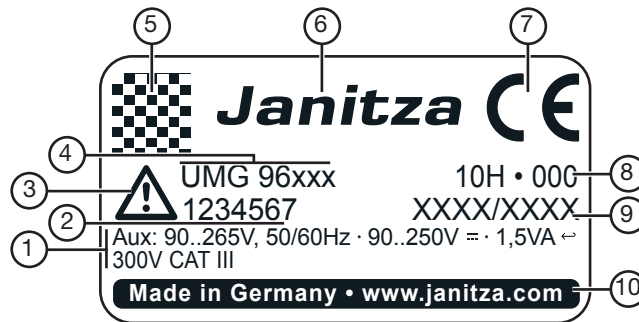

Fig. Rating plate

Pos.	Designation	Description
1	Operating data	AC supply voltage in V Nominal frequency in Hz DC supply voltage in V Power consumption in VA Overvoltage category
2	Item number	Item number of the manufacturer
3	“Danger sign” symbol	General danger symbol. Observe the warning notices depicted on the device and listed in the documents in order to prevent injuries or even death.
4	Device type	Device designation
5	QR code	Coded manufacturer data
6	Manufacturer logo	Logo of the device manufacturer
7	CE mark	See chap. „3.7 EC declaration of conformity“ on page 14
8	Manufacturer-specific data	Coded manufacturer data
9	Type/serial number	Number for identifying the device
10	Designation of origin/web address	Country of origin and web address of the manufacturer

## 4. Assembly

### 4.1 Installation location

Install the device in stationary and weather-protected front panels of switching cabinets in the interior.

#### ATTENTION

##### Property damage due to noncompliance with the assembly instructions!

Noncompliance with the assembly instructions can damage or destroy your device.

- Observe the information for the installation location in the “Assembly” and “Technical data” sections.
- Ensure sufficient air circulation in your installation environment and, where applicable, sufficient cooling with high temperatures!
- Ground conductive switchboards!

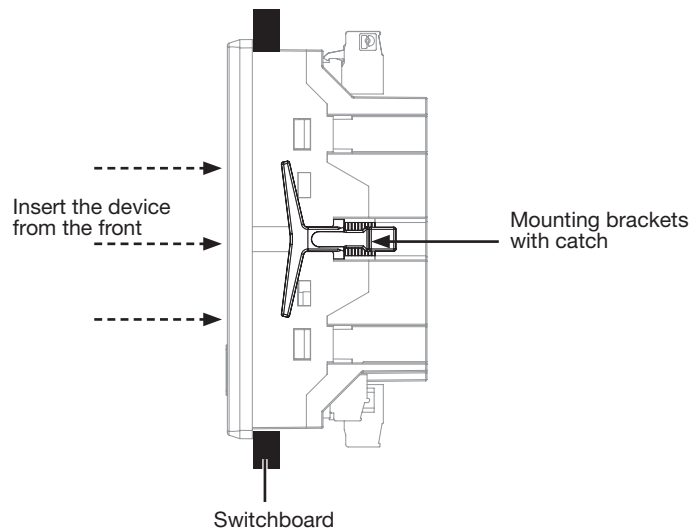

Fig. Side view of the device - fastening with snap-on mounting brackets.

### 4.2 Installation position

- Cut-out size:  $92^{+0.8}$  mm x  $92^{+0.8}$  mm.
- For sufficient ventilation, adhere to the distances to neighboring parts.
- The installation position is discretionary.

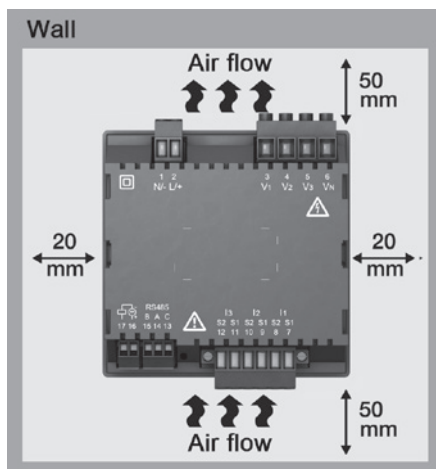

Fig. Rear view of the installation position of the device.

### 4.3 Fastening

Fasten the device with the **mounting brackets (snap-on mounting brackets)** belonging to the scope of delivery as follows:

1. Remove the mounting brackets (snap-on mounting brackets) on the device.
2. Insert the device from the front into the recess ( $92^{+0.8}$  mm x  $92^{+0.8}$  mm) of your switchboard.
3. Slide the mounting brackets (snap-on mounting brackets) onto the catch provided for this until the device audibly snaps in place and is firmly seated in your switchboard.

## 5. Network systems

Network systems and maximum rated voltages according to DIN EN 61010-1/A1:

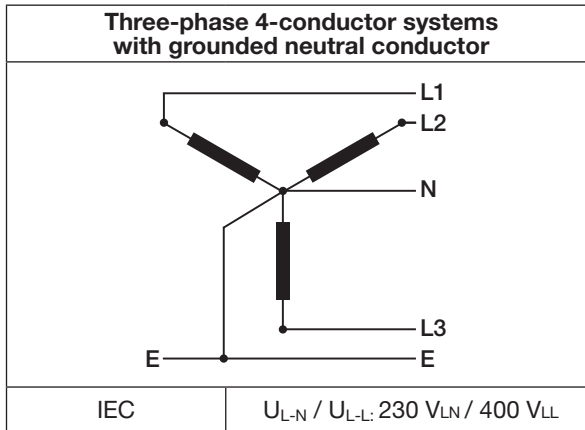

- The device can be used in
- TN and TT networks,
  - Residential and industrial sectors.

<b>⚠ WARNING</b>
<p><b>Risk of injury due to electric voltage!</b> Measurement voltage surges over the approved overvoltage category can damage insulation in the device. The safety of the device will be impaired. This can result in serious personal injuries or death.</p> <ul style="list-style-type: none"> <li>· Only use the device in environments in which the permissible measurement voltage surge can be observed.</li> <li>· Observe the threshold values specified in the user manual and on the rating plate.</li> </ul>

## 6. Installation

<b>⚠ WARNING</b>
<p><b>Disregard of the connection conditions of the transformers to Janitza measurement devices or their components can lead to injuries or even death or to material damage!</b></p> <ul style="list-style-type: none"> <li>· Do not use Janitza measurement devices or components for critical switching, control or protection applications (protective relays)! It is not permitted to use measured values or measurement device outputs for critical applications!</li> <li>· For Janitza measurement devices and their components use only "Transformers for measurement purposes" which are suitable for the energy monitoring of your system. Do not use "Transformers for protection purposes"!</li> <li>· Observe the information, regulations and limit values in the usage information on "Transformers for measuring purposes", specifically during testing and commissioning of the Janitza measurement device, the Janitza component and your system.</li> </ul>

Use the device for voltage measurement in TN and TT systems with the approved overvoltage category of 300 V CAT III (measurement voltage surge 4 kV).

<b>⚠ WARNING</b>
<p><b>Risk of injury due to electric voltage!</b> Short circuited connections of voltage transformers on the secondary side can result in serious personal injuries or death.</p> <ul style="list-style-type: none"> <li>· Do not short circuit secondary sides of voltage transformers!</li> <li>· Connect voltage transformers according to their documentation! Check the installation!</li> </ul>

### 6.1 Rated voltages

Lists and circuit diagrams with rated voltages of networks for using your device:

#### 6.1.1 Three-phase 4-conductor network with grounded neutral conductor

$U_{L-N} / U_{L-L}$	
66 V / 115 V	
120 V / 208 V	
127 V / 220 V	
220 V / 380 V	
230 V / 400 V	Maximum rated voltage of the network for the device

Fig. Suitable network rated voltages for measurement inputs according to EN 60664-1:2003

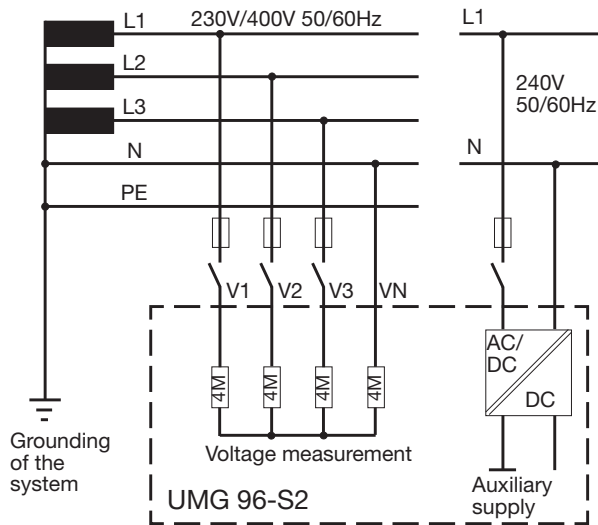

Fig. Schematic diagram - measurement in three-phase 4-conductor system

## 6.2 Disconnectors

Provide a suitable disconnector for the supply voltage in the building installation in order to de-energize the device from current and voltage.

- Install the disconnector near the device in a location that is easily reachable for the user.
- Mark the switch as a disconnecting device for this device.

## 6.3 Supply voltage

A supply voltage is required for operation of the device. The type and level of the supply voltage for your device can be found on the rating plate.

The connection of the supply voltage is made via the plug-type terminals on the rear side of the device.

Before connecting the supply voltage, ensure that the voltage and frequency correspond to the specifications on the rating plate.

Connect the supply voltage via a UL/IEC-approved fuse.

After connecting the supply voltage, a display appears. If no display appears, check:

- the connection of your device.
- the supply voltage.

## ⚠ WARNING

### Risk of injury due to electric voltage!

Serious personal injuries or death can occur due to:

- Touching live exposed or stripped cores.
- Device inputs that are dangerous to touch.

**Before starting work, disconnect your system from the power supply! Verify that there is no current!**

## ⚠ ATTENTION

### Property damage due to noncompliance with the connection conditions.

Noncompliance of the connection conditions or exceeding the permissible voltage range can damage or destroy your device.

### Before you connect the device to the supply voltage, please observe the following:

- The voltage and frequency must comply with the specifications on the rating plate.
- Observe the limit values as described in the user manual.
- In building installations, secure the supply voltage with a UL/IEC-listed circuit breaker/fuse.
- The disconnect device:
  - must be easily accessible for the user and located in the vicinity of the device.
  - must be labeled for the respective device.
- Do not tap the supply voltage at the voltage transformers.
- Provide a fuse for the neutral conductor if the neutral conductor connection is not grounded to the source.

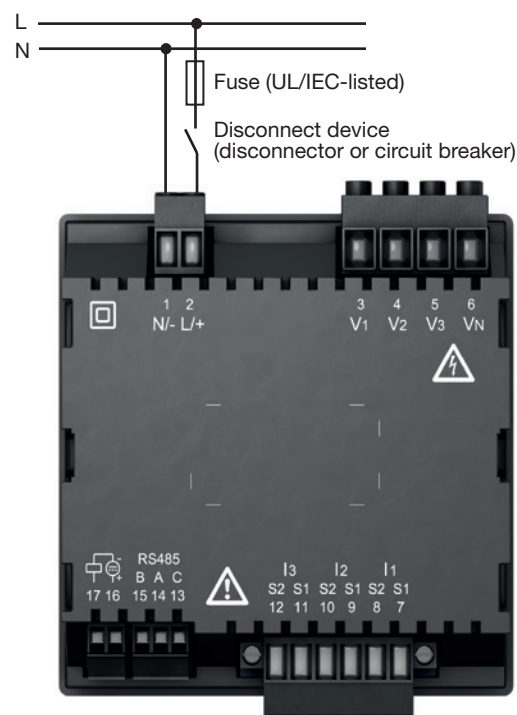

Fig. Supply voltage connection.

**Recommendation for overcurrent protection device for the line protection of the supply voltage:**

6 - 16 A (Char. B, IEC-/UL approval)

**Recommendation for the maximum number of devices on one circuit breaker:**

- B6A maximum 4 devices.
- B16A maximum 11 devices.

**NOTE**

The fuse is only a line protection - it is not a device protection!

**6.4 Voltage measurement**

The device has 3 voltage measurement inputs and is suitable for different connection versions.

**⚠ WARNING**

**Risk of injury or damage to the device due to electric voltage and improper connection!**  
 Noncompliance with the connection conditions for the voltage measurement inputs can damage the device or cause serious injury and even death.  
 Therefore, please observe the following:

- Before starting work, disconnect your system from the power supply! Verify that there is no current.
- The voltage measurement inputs
  - must not be connected to DC current.
  - must be provided with a suitable, labeled fuse and circuit breaker (alternative: miniature circuit breaker) in their immediate vicinity.
  - are dangerous to touch.
- Voltages that exceed the allowed nominal network voltages must be connected via voltage transformers.
- Measured voltages and measured currents must originate from the same network.

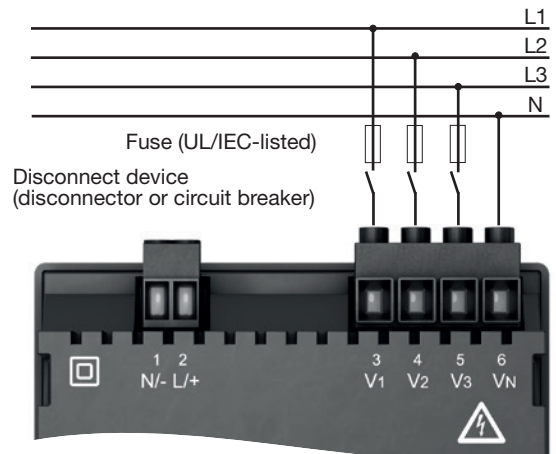

Fig. "Direct voltage measurement in a three-phase 4-conductor systems" connection version.

**6.4.1 Voltage swell**

The voltage measurement inputs are designed for measurements in low-voltage networks (4-conductor system) in which rated voltages occur up to 230 V phase to ground and 400 V phase to phase.

The rated voltages and surge voltages correspond to overvoltage category 300 V CATIII (measurement voltage surge 4 kV).

## 6.4.2 Mains frequency

The device:

- requires the mains frequency for the measurement and calculation of measured values.
- is suitable for measurement in networks in which the mains frequency of the voltage is in the range of 45 Hz to 65 Hz.
- requires a voltage L1-N of greater than 10 V<sub>eff</sub> at the voltage measurement input V1 for the automatic determination of the mains frequency.
- calculates the sampling rate of the voltage and current measurement inputs from the mains frequency.

If the measured voltage is missing, then the mains frequency cannot be determined and thus the sampling rate cannot be calculated. The acknowledgeable error message “500” appears. Voltage, current and all other resulting values are calculated on the basis of the last frequency measurement and based on possible electric couplers and are continuously displayed. The measured values determined are no longer subject to the specified accuracy.

If the measurement of the mains frequency is possible again, the device hides the error message approx. 5 seconds after voltage recovery.

### NOTE

The device only determines the measured values if voltage L1-N is greater than 20 V<sub>eff</sub> (4-conductor measurement) or voltage L1-L2 is greater than 34 V<sub>eff</sub> (3-conductor measurement) at voltage measurement input V1.

Use a line protection (1 - 10 A) with IEC/UL approval as fuse protection for the voltage measurement.

## 6.4.3 Voltage measurement connection versions

### Three-phase 4-conductor systems

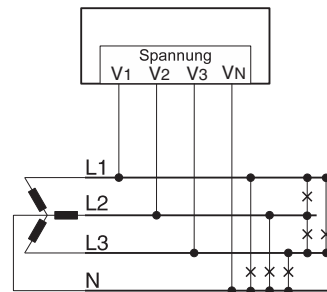

Voltage measurement in the three-phase 4-conductor systems

### Single phase 3-conductor system

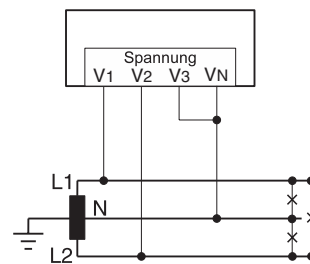

Voltage measurement in the single-phase 3-conductor system

### NOTE

Voltage

- The device only permits setting one voltage transformer ratio for all phases!
- You can easily configure the voltage transformer ratios via
  - the device menu.
  - the GridVis® software.
- For information on programming the voltage transformer, see chap. 12.6 on page 37.
- For information on exceeding the measurement range, see chap. 17.4 on page 58.

### 6.5 Current measurement

The device

- is only approved for a current measurement using the current transformer.
- is designed for the connection of current transformers with secondary currents of  $\dots/1$  A and  $\dots/5$  A.
- has the current transformer ratio set to 5/5 A by default (adjust to the current transformer used, if necessary).
- does not measure DC currents.

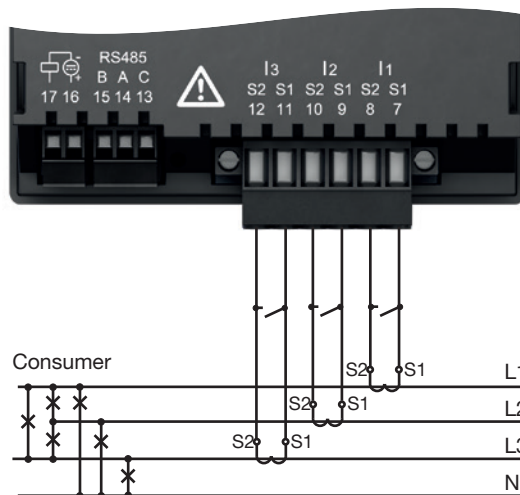

Fig. "Current measurement via current transformer" connection

#### **⚠ WARNING**

##### **Risk of injury due to high currents and high electrical voltages!**

- Serious personal injuries or death can occur due to:
- Touching live exposed or stripped cores.
  - Device and current transformer inputs that are dangerous to touch.
- Therefore, please observe the following for your system:
- Before starting work, disconnect it from the power supply!
  - Secure it against being switched back on!
  - Determine that there is no current!
  - Ground the system! Use the ground connection point with the ground symbol for this.
  - Cover or block off neighboring parts that are under voltage!

#### **⚠ WARNING**

##### **Risk of injury due to electric voltage on current transformers!**

High voltage spikes that are dangerous to touch can arise on current transformers that are operated open on the secondary side, which can result in serious injuries or even death.

##### **Therefore, please observe the following:**

- Before starting work, disconnect your system from the power supply! Verify that there is no current.
- Avoid open operation of the current transformer.
- Short circuit unloaded current transformers.
- Before interrupting the power supply, short circuit the secondary connections of the current transformer.
- If a test switch is present that automatically short circuits the secondary lines of the current transformer, it is sufficient to put it in the "test" position provided that the short-circuiters have been checked beforehand.
- Only use current transformers that have a basic insulation according to IEC 61010-1:2010.
- Fasten the attached screw-type terminal to the device with the two screws.
- Even safe open current transformers are dangerous to touch if they are operated open.

#### **⚠ WARNING**

##### **Risk of injury or damage to the device due to electric voltage and improper connection!**

During high measured currents, temperatures up to 80 °C can arise at the connections. **Use lines which are designed for an operating temperature of at least 80 °C!**

### 6.5.1 Current measurement connection versions

#### Three-phase 4-conductor systems

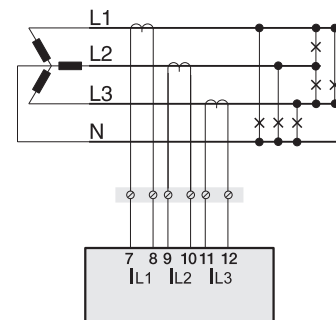

Current measurement via the current transformer in the three-phase 4-conductor systems

#### Single phase 3-conductor system



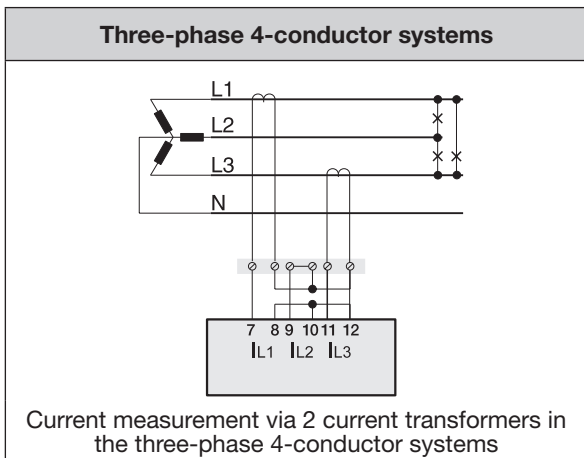
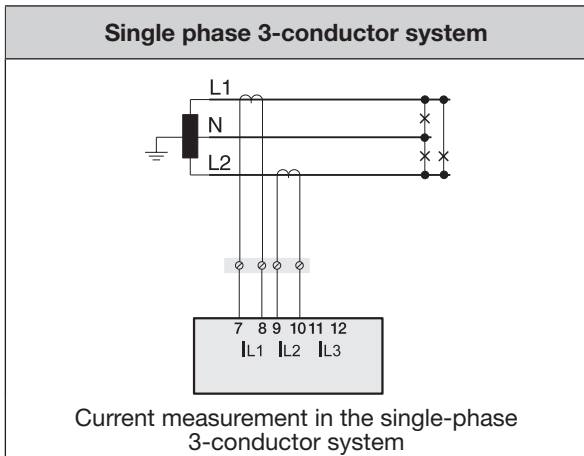

**NOTE**

- The device only permits setting one current transformer ratio for all phases!
- You can easily configure the current transformer ratios via
  - the device menu.
  - the GridVis® software.
- For information on programming the current transformer, see chap. 12.5 on page 37.
- For information on exceeding the measurement range, see chap. 17.4 on page 58.

**6.5.2 Summation current measurement**

For a summation current measurement via two current transformers, first set their total transformation ratio on the device (setting the current transformer ratios, see starting from chap. 12.4 on page 36).

**Example:**

The current measurement occurs via two current transformers. Both current transformers have a transformation ratio of 1000/5 A. The summation measurement is performed with a summation current transformer 5+5/5 A.

Set the device as follows:

Primary current: 1000 A + 1000 A = **2000 A**

Secondary current: **5A**

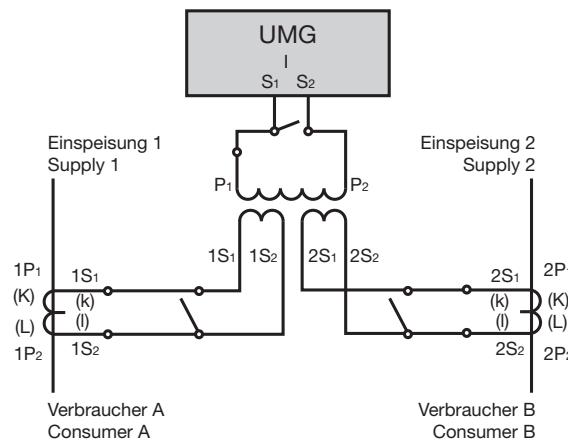

Fig. Example for the current measurement via a summation current transformer

**6.5.3 Ammeter**

For a current measurement with an additional ammeter, connect the ammeter in series to the UMG:

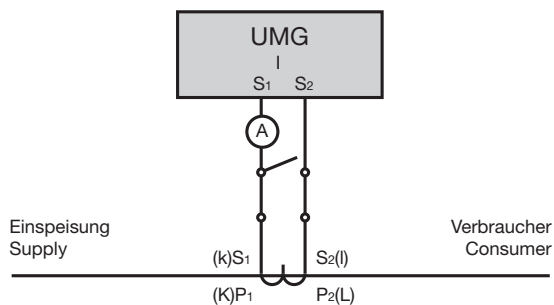

Fig. Circuit diagram with ammeter in series connection

## 7. Connection

### 7.1 Connection to a PC

The following common connection methods are described for the communication of the derive with a PC (with installed GridVis®software).

1. Connection via interface converter:

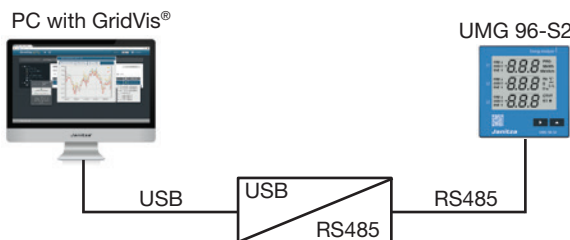
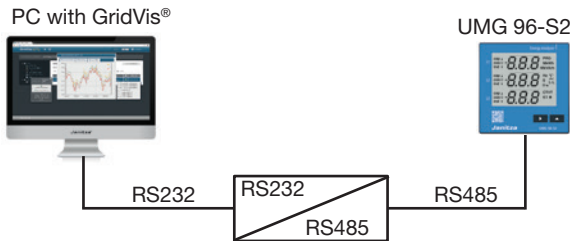

2. Connection via a master device (UMG 512-PRO) as a gateway:

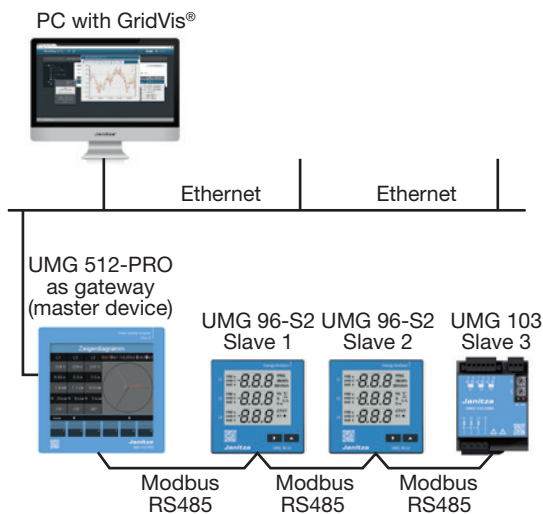

### ATTENTION

**Property damage due to incorrect network settings.**

Incorrect network settings can cause faults in the IT network!

**Consult your network administrator for the correct network settings for your device.**

### NOTE

In an RS485 bus structure, observe the address settings for your master device in the respective documentation.

## 7.2 RS485 interface (serial interface)

The RS485 interface for this device is designed as a 3-pole plug contact and communicates via the Modbus RTU protocol.

Recommended cable type:

- Unitronic Li2YCY(TP) 2x2x0.22 (Lapp Kabel).

Connection capacity of the terminal:

- 0.2 - 1.5 mm<sup>2</sup> (see chap. „18. Technical data“ on page 60)

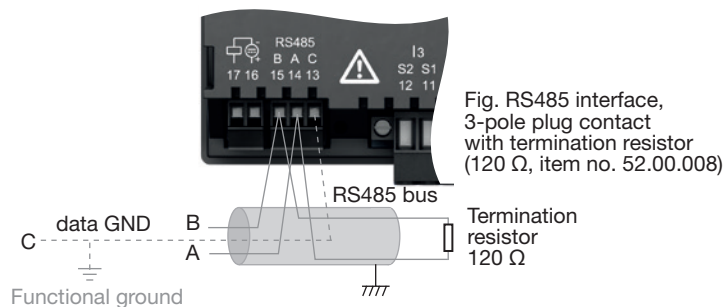
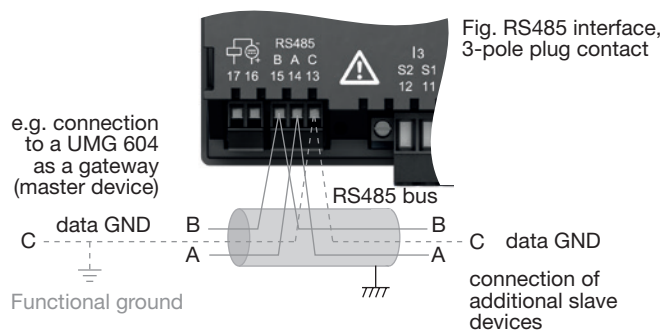

### NOTE

- CAT cables are not suitable for the bus wiring! Use the recommended cable type (see above).
- A segment of an RS485 bus structure can contain up to 32 participants/devices. Use repeaters to connect segments with more than 32 participants/devices.
- To prevent the addition of residual current when using several devices, mount the data GND as a functional ground (see fig.)!
- To prevent the measurement device from displaying a residual voltage, connect terminal „C“ of the RS-485 interface of your measurement device as the functional earth (FE) to the PE conductor of your system. Use the color „pink“ (DIN EN 60445/VDE 0197) for the functional earth lead.
- The device does not contain an integrated termination resistor (see chap. „8.4 Termination resistors“ on page 28).

### 7.3 Shielding

For connections via the interfaces, provide a twisted and shielded cable and observe the follow points for the shielding:

- Ground the shields of all cables that lead into the cabinet at the cabinet entrance.
- Connect the shield over a large area and with good conductivity to a noiseless ground.
- Do NOT connect the shield to terminal C (GND).
- Mechanically trap the cable above the grounding clamp in order to prevent damage due to movements of the cable (tension relief).

Use appropriate cable entries for guiding the cable into the switching cabinet, for example, PG glands.

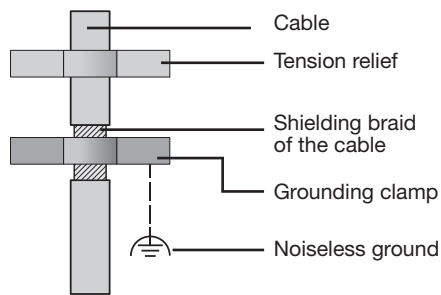
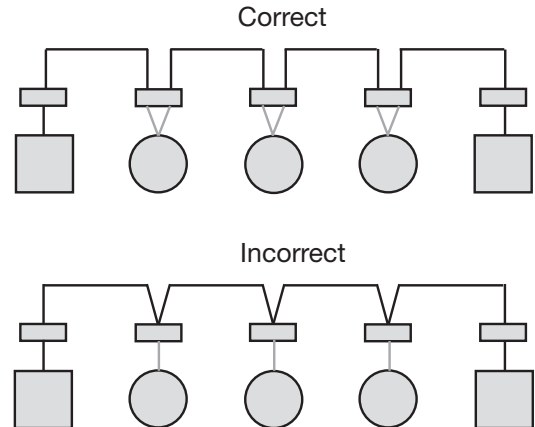

Fig. Shielding design at cabinet entrance.

### 7.4 Termination resistors

Terminate your cable at the start and end of a segment with resistors (120 ohm, 0.25 W). The device does not contain an integrated termination resistor!



- Terminal strip (switching cabinet).
- Device with RS485 interface (without termination resistor).
- Device with RS485 interface (termination resistor on the device).

#### **⚠ WARNING**

##### **Risk of injury due to high currents and high electrical voltages!**

Due to atmospheric discharge, errors in the transmission and dangerous voltages on the device can arise. Therefore, please observe the following:

- Place the cable shield at least once on functional ground (PE).
- With larger interfering sources or frequency converters in the switching cabinet, connect the shielding as close as possible on the device to the functional ground (PE).
- Adhere to the maximum cable length of 1200 m at a baud rate of 38.4 k.
- Use shielded cables.
- Lay interface lines spatially separated or additionally insulated from the system parts carrying mains voltage.

## 7.5 Bus structure

In a bus structure

- all devices are connected in line.
- each device has its own address (see chap. „12.7 Programming the parameters“ on page 38).
- up to 32 participants/devices can be interconnected in a segment. The cable is terminated with resistors (bus terminator, 120 ohm, 1/4 W) at the start and end of a segment.
- repeaters (line amplifiers) are used for more than 32 participants to connect the segments.
- devices with an activated bus terminator must be supplied with power.

- placing the master at the end of a segment is recommended. If the master is replaced with an activated bus terminator, the bus is deactivated.
- the bus can become unstable if a slave is replaced with an activated bus terminator or is de-energized.
- devices, which do not participate in the bus terminator, can be replaced without making the bus unstable.

Fig. Representation of a bus structure

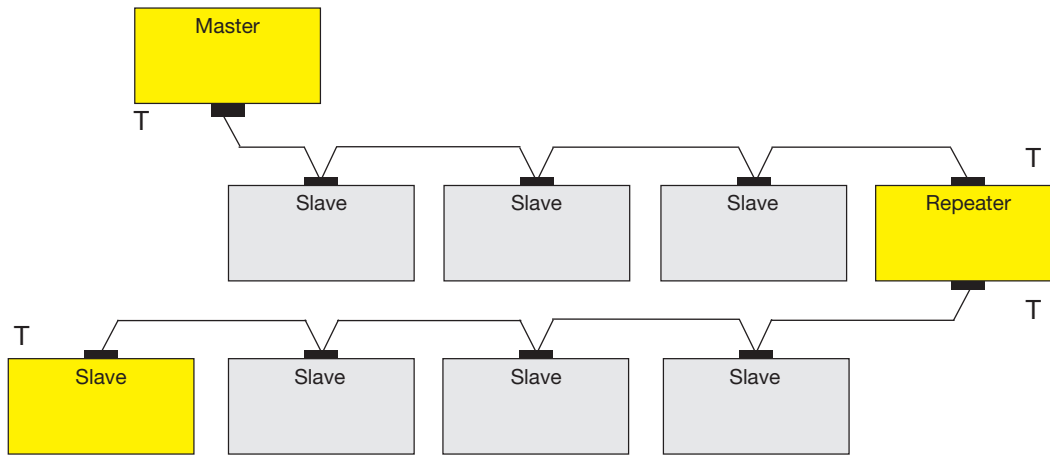

- Power supply necessary
- T - Bus terminator switched on

Master - e.g. UMG 604-PRO

Slave - UMG 96-S2

## 8. Communication via the RS485 interface with the Modbus RTU protocol

Via the Modbus RTU protocol with CRC check on the RS485 interface, you will attain

- Data from the parameter list and
- Measured values from the Modbus address list.

Setting range of the device addresses: 1 .. 247  
 Standard setting: 1  
 Standard setting for baud rate in kbps: 38.4

### Modbus functions (slave)

- 04 Read input registers
- 06 Preset single register
- 16 (10Hex) Preset multiple registers
- 23 (17Hex) Read/write 4X registers

The order of the bytes is high byte before low byte (Motorola format).

### Transmission parameters:

- Data bits: 8
- Parity: odd, even, none (1 stop bit), none (2 stop bits)
- Stop bits (device): 1/2
- Stop bits, external: 1/2

Number formats: short 16 bit ( $-2^{15} .. 2^{15} - 1$ )  
 float 32 bit (IEEE 754)

Designation	Hex	Remark
Device address	01	UMG 96-S2, address = 1
Function	03	
Byte counter	06	
Data	00	00hex = 00dec
Data	E6	E6hex = 230dec
Error check (CRC)	-	

The voltage L1-N read by the address 19000 is 230 V.

### NOTE

- The device does not support a broadcast (address 0).
- The telegram length may not exceed 256 bytes.

### Example: Reading out the voltage L1-N

- The voltage L1-N is archived
- in address 19000 of the measured value list.
- in FLOAT format.

The device address for the device is accepted here with address = 01.

The "Query message" then appears as follows:

Designation	Hex	Remark
Device address	01	UMG 96-S2, address = 1
Function	03	"Read holding reg."
Start address Hi	4A	19000dec = 4A38hex
Start address Lo	38	
Number of Hi values	00	2dec = 0002hex
Number of Lo values	02	
Error check (CRC)	-	

The "Response" of the device can then appear as follows:

## 9. Digital output

The device has an electrically isolated digital output, which outputs the active energy, reactive energy or apparent energy obtained as an S0 interface.

### 9.1 Pulse output function

After reaching a specific, adjustable amount of energy, the device sends a pulse of a defined length to the output. To use the digital output (pulse output), configure

- the energy measured value (which is to be output, parameter address 100),
- the pulse value (parameter address 102) and
- the pulse length (pulse pause, parameter address 106).

### 9.2 Pulse output connection example

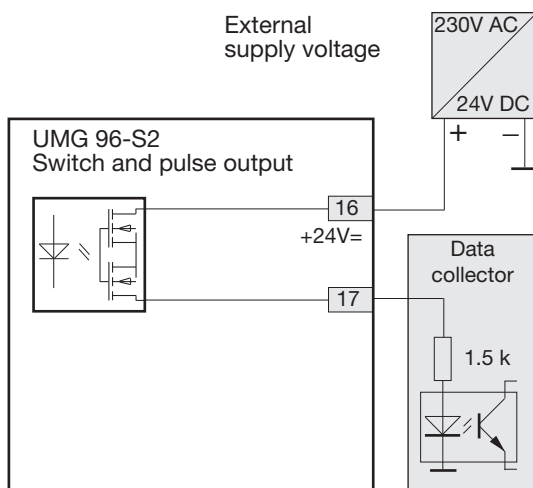

Fig. Connection example of pulse output

### 9.3 Pulse value (parameter address 102)

The pulse value specifies how much energy (Wh or varh) a pulse should correspond to. The pulse value is determined by the maximum connected load and the maximum number of pulses per hour.

- If the pulse value is specified with a positive sign, pulses are only output if the measured value also has a positive sign.
- If the pulse value is specified with a negative sign, pulses are only output if the measured value also has a negative sign.

$$\text{Pulse value} = \frac{\text{max. connected load}}{\text{max. number of pulses/h}} \text{ Wh/Pulse}$$

#### NOTE

- Since the active energy counter works with a non-return device, pulses are only output during consumption of electrical energy.
- Since the reactive energy counter works with a non-return device, pulses are only output during an inductive load.

#### NOTE

The maximum residual ripple for the auxiliary voltage (DC) for the digital output (pulse output) may be 5%.

### 9.4 Pulse length (parameter address 106) and pulse pause

#### Pulse length

The pulse that is sent at the pulse output S0 of the device consists of the pulse length and the pulse pause. The pulse length is set via the parameter address 106:

Setting range (address 106):

**10 .. 1000, 10 = 10 ms**

Standard setting:

**50 = 50 ms**

The typical pulse length for S0 pulses is 30 ms.

#### Pulse pause

The pulse pause is

- at least as long as the selected pulse length.
- dependent on the e.g. measured energy and can be hours or days.

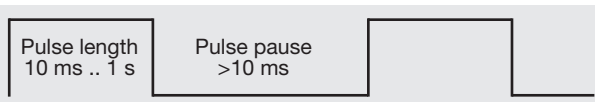

Fig. Example of pulse length and pulse pause

Due to the minimum pulse length and the minimum pulse pause, the following values for the maximum number of pulses per hour result:

Setting of address 106	Pulse length	Pulse pause	Max. pulses/h
10	10 ms	10 ms	180 000
30	30 ms	30 ms	60 000
50	50 ms	50 ms	36 000
100	100 ms	100 ms	18 000
500	500 ms	500 ms	3 600
1000	1 s	1 s	1 800

Examples for the maximum possible number of pulses per hour.

#### NOTE

##### Pulse interval

- The pulse interval is proportional to the power within the selected settings.

##### Measured value selection

- During the programming with the GridVis software, you will receive a selection of energy measured values which are derived from the power values.

### 9.5 Determining the pulse value

#### Establishing the pulse length

Establish the pulse length according to the requirements of the connected pulse receiver.

With a pulse length of e.g. 30 ms, the device can emit a maximum number of 60,000 pulses per hour (see table „Examples for the maximum possible number of pulses per hour.“ on page 32).

#### Calculating the maximum connected load

Example:

Current transformer = 150/5 A  
Voltage L-N = max. 300 V

Power per phase (U x I) = 150 A x 300 V = 45 kW  
Power with 3 phases = 45 kW x 3

Max. connected load = 135 kW

#### Calculating the pulse value

$$\text{Pulse value} = \frac{\text{max. connected load}}{\text{max. number of pulses/h}} \text{ Wh/pulse}$$

Pulse value = 135kW / 60000 pulses/h  
Pulse value = 0.00225 kWh/pulse  
Pulse value = 2.25 Wh/pulse



## 10. Operation and button functions

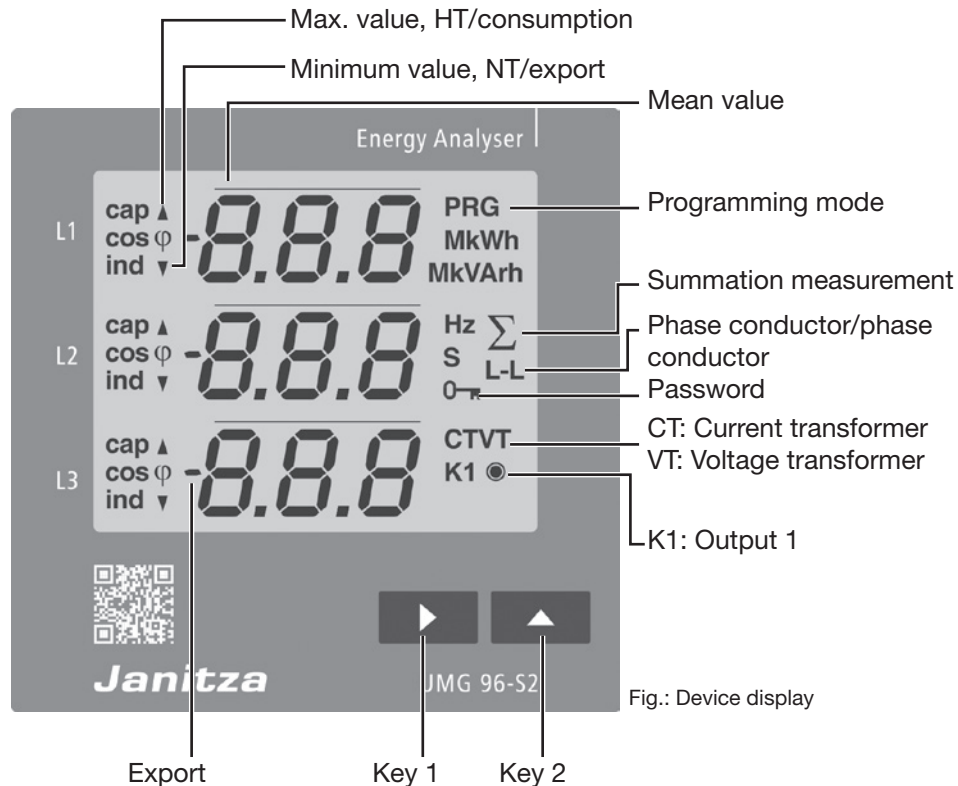

### 10.1 Operation

The device presents measured values and programming data on a liquid crystal display.

The operation occurs via the keys 1 and 2 with following differences:

- briefly pressing (key 1 or 2):  
next step (+1).
- long pressing (key 1 or 2):  
previous step (-1).

The device distinguishes between **display mode** and **programming mode**:

#### Display mode

- Page between the measured value displays using keys 1 and 2.
- The measured value display shows up to 3 measured values.
- A time for the automatic display change between the measured value displays can be configured in the GridVis® software.

#### Programming mode

- Hold down key 1 and 2 simultaneously for 1 second in order to switch between display mode and programming mode. The text PRG appears in the display.
- The settings necessary for the operation of the device are configured in programming mode.
- Programming mode can be protected with a user password (only on the device).
- Switch between the programming menus using key 2:
  1. Current transformer
  2. Voltage transformer
  3. Parameter list

To switch from **programming mode** into **display mode**,

- press keys 1 and 2 simultaneously for 1 s.
- Do not press any keys for 60 s (automatic).



#### NOTE

Changes only become active after exiting programming mode.

### 10.2 Button functions

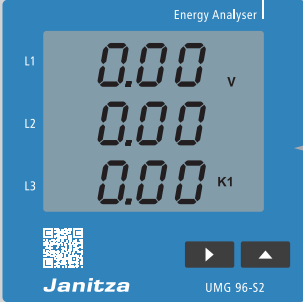
#### Display mode





**Switch mode:**  
   
 press  
 simultaneously  
 Password

---

#### Scroll

Measured values 3c	Measured values 3b	Measured values 4a
Measured values 3c	Measured values 3b	Measured values 3a
Measured values 2c	Measured values 2b	Measured values 2a
Measured values 1c	Measured values 1b	Measured values 1a
Measured values Xc	Measured values Xb	Measured values Xa

press briefly  press and hold 

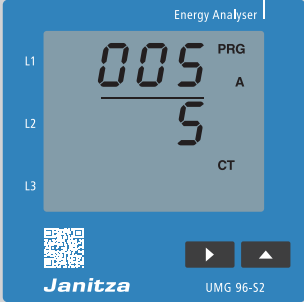

press briefly  press and hold

#### Programming mode



---











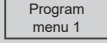

#### Scroll

press briefly  press and hold 

Program menu 4
Program menu 3
Program menu 2
Program menu 1
Program menu X

---

#### Program

1.   press briefly  
Selection confirmed
2.   press briefly - number +1  
press and hold - number -1
3.    press briefly - number +1  
press and hold - number -1
4.    press briefly - number +1  
press and hold - number -1
5.    press briefly - value x10  
(decimal place to the right)  
press and hold - value /10  
(decimal place to the left)
6. Program all values according to this scheme.
7. After completing the programming, switch to the display mode by pressing key 1 and 2 simultaneously. If no entry occurs for 60 s in programming mode, the display switches automatically.

### 10.3 Parameter (addresses) and measured value display

#### 10.3.1 Parameter (addresses)

All parameters required for the device, such as current transformer data, voltage transformer data and a selection of frequently required measured values, can be found in chap. „18.2 Parameter and Modbus address list“ on page 64.

The contents of most parameter addresses are reached via the serial interface (RS485), e.g. with a connected PC with the GridVis® software or with keys 1 and 2 on the device.

Parameter addresses (3-digit) are configured in programming mode.

#### 10.3.2 “Parameter address” example display

The display of the device shows the parameter address for the device address of the device within an RS485 bus structure.

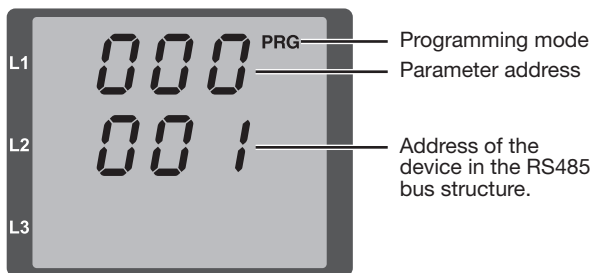

Fig. Parameter address example display

#### 10.3.3 Measured value display

The device summarizes selected measured values in 3 measured value display profiles. The measured values appear in the display mode of the device depending on the set display profile (address 037).

In addition to the measured value display profiles, the device has the option of selecting measured value profiles for an automatic display change (address 038).

The measured value display profiles and the automatic display change profiles are read and changed via the serial interface (RS485), e.g. with a connected PC (GridVis® software) or with keys 1 and 2 on the device. For additional information on this, see chap. „14. Measured value display and automatic display change profile“ on page 46.

#### 10.3.4 Example of measured value display

The display of the device shows the voltages (L-N) each at 230 V. The transistor output K1 conducts and current can flow.

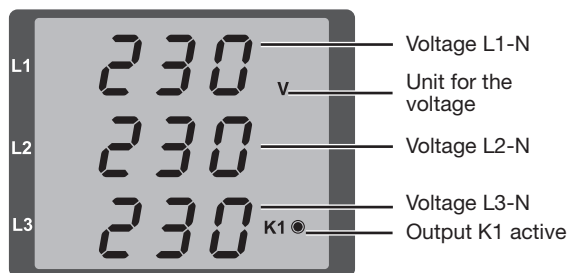

Fig. Example of measured value display

#### NOTE

The measured value display and the display change profile are easily configured via the GridVis® network visualization software!

## 11. Configuration

### 11.1 Connecting the supply voltage

To configure the device, connect the supply voltage. Observe the general safety instructions while doing so, as described in chap. „2. Safety“ on page 10.

The supply voltage level can be found on the rating plate of the device or in chap. „18. Technical data“ on page 60.

If no device display appears, check whether the supply voltage is within the rated voltage range.

<b>⚠ WARNING</b>
<p><b>Risk of injury or damage to the device due to too high electric voltage!</b>          Serious personal injuries up to death, or device malfunctions up to destruction, can occur!          Therefore, please observe the following:</p> <ul style="list-style-type: none"> <li>· Do not exceed the threshold values stated in the user manual and on the rating plate; this must also be observed during inspection and commissioning.</li> <li>· Safety instructions and warning notices in the documents that accompany the devices and their components!</li> </ul>

<b>NOTE</b>
<p>The device requires approximately 20 s to determine the mains frequency. During this time period, the assured measurement uncertainty does not apply for measured values!</p>

### 11.2 Programming mode

The device has a programming mode, in which 3 main settings can be programmed:

1. **Current transformer**
2. **Voltage transformer**
3. **Parameter lists** (for setting ranges, see chap. „18.2 Parameter and Modbus address list“ on page 64).

Everything on the display mode and programming mode can be found in chap. „11. Operation and button functions“ on page 33.

### 11.3 Password protection

In order to hinder an accidental change of the programming data, a user password can be programmed. More detail in chap. „12.7.6 User password (parameter address 050)“ on page 39.

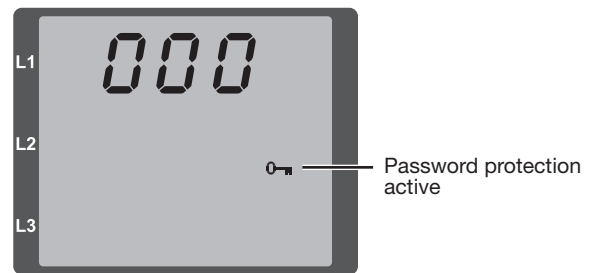

Fig. Password request. The entry occurs via the keys 1 and 2.

### 11.4 Current transformer and voltage transformer

For the use of current transformers, configure the current transformer ratio for your device if necessary (standard setting: 5/5 A).

<b>NOTE</b>
<p>For suitable operating values, do not set the value 0 for the primary current transformer!</p>

For the use of voltage transformers, configure a voltage transformer ratio.

<b>NOTE</b>
<p>Observe the specified measured voltage during the connection of voltage transformers.</p>

Configure the transformation ratio of the respective group for the current measurement inputs I1-I3 or voltage measurement inputs V1-V3.

<b>NOTE</b>
<p>The transformation ratio of the current transformer and voltage transformer can also be configured via the GridVis® network visualization software!</p>

### 11.5 Programming the current transformer

1. Switch into programming mode.
2. The symbols **PRG** for the programming mode and **CT** for the current transformer appear.
3. Confirm with key 1 - the first number of the input area for the primary current flashes.
4. Using key 2, select the value for the 1st number.
5. Using key 1, switch to the 2nd number.
6. Using key 2, select the value for the 2nd number.
7. Using key 1, switch to the 3rd number.
8. Using key 2, select the value for the 3rd number.
9. Confirm using key 1.
10. The complete number flashes.
11. Select the decimal place and therefore the unit of the primary current using key 2.
12. Confirm using key 1.
13. The input area for the secondary current flashes.
14. Set the secondary current (value 1 A or 5 A) using key 2.
15. Confirm using key 1.
16. Exit programming mode by simultaneously pressing key 1 and 2 (1 s). Switch to the input area for the voltage transformer using key 2.

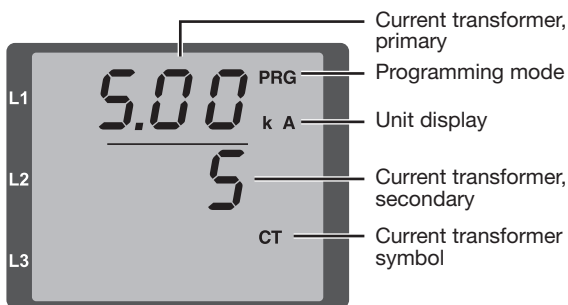

Fig. "Current transformer" input area

#### NOTE

Changes only become active after exiting programming mode.

### 11.6 Programming the voltage transformer

1. Switch into programming mode.
2. The symbols **PRG** for the programming mode and **CT** for the current transformer appear.
3. Switch into programming mode for the voltage transformer using key 2.
4. The symbols **PRG** for the programming mode and **VT** for the voltage transformer appear.
5. Confirm with key 1 - the first number of the input area for the primary voltage flashes.
6. Using key 2, select the value for the 1st number.
7. Using key 1, switch to the 2nd number.
8. Using key 2, select the value for the 2nd number.
9. Using key 1, switch to the 3rd number.
10. Using key 2, select the value for the 3rd number.
11. Confirm using key 1.
12. The complete number flashes.
13. Select the decimal place and therefore the unit of the primary voltage using key 2.
14. Confirm using key 1.
15. The input area for the secondary voltage flashes.
16. Set the secondary voltage using key 2.
17. Confirm using key 1.
18. Exit programming mode by simultaneously pressing key 1 and 2 (1 s). Switch into programming mode for the parameter list using key 2.

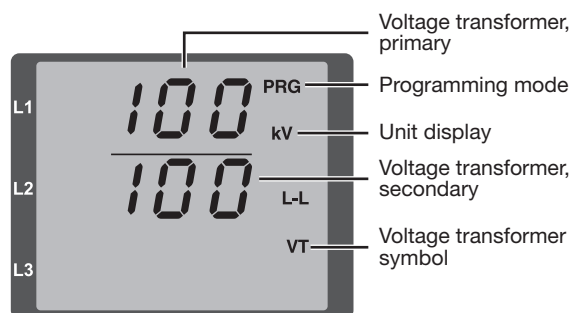

Fig. "Voltage transformer" input area

#### NOTE

Changes only become active after exiting programming mode.

### 11.7 Programming the parameters

1. Switch into programming mode.
2. The symbol **PRG** for the programming mode appears.
3. Switch into programming mode for the parameter list by pressing key 2 twice.
4. The input area for the parameter address appears.

**NOTE**

- The parameter addresses for the device address (000) and the baud rate (001) are explained next.
- A parameter list with the most important setting ranges and default settings can be found in chap. „18.2 Parameter and Modbus address list“ on page 64 or the Modbus address list on our web site.

5. Confirm with key 1 - the first number of the parameter address flashes.
6. Using key 2, select the value for the 1st number.
7. Continue the procedure for the next numbers of the parameter address and for the parameter settings.
8. Exit programming mode by simultaneously pressing key 1 and 2 (1 s). Switch back to the input area for the current transformer using key 2.

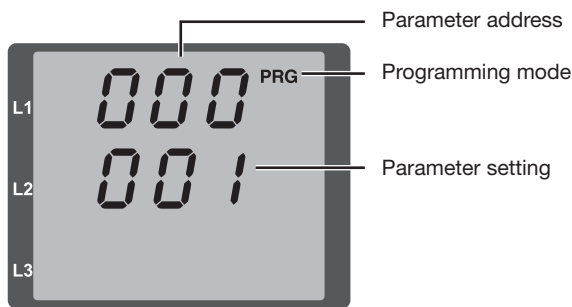

Fig. "Parameter list" input area

#### 11.7.1 Setting the device address (parameter address 000)

A master device can distinguish the UMGs based on the device address in a master/slave network via the RS485 interface.

For devices within this network, ensure the following:

- different device addresses are assigned.
- the device address is within the range of 1 to 247 (0 and 248 to 255 are reserved).

#### 11.7.2 Setting the baud rate (parameter address 001)

For each device in a master/slave network via the RS485 interface:

- select a consistent baud rate (parameter address 001) (0= 9.6 kbps, 1=19.2 kbps, 2=38.4 kbps).
- select the number of stop bits (parameter address 002) (0=1 bit, 1=2 bits, 2=1 bit even parity, 3=1 bit odd parity).

Data bits (8) are fixed.

Parameter setting	Baud rate
0	9.6 kbps
1	19.2 kbps
2	38.4 kbps (standard setting)

Tab. Baud rate setting in the parameter address 001

#### 11.7.3 Mean values and averaging times (parameter address 040, 041 and 042)

To establish mean values for the current, power and voltage measured values, the device requires averaging times.

The device

- identifies mean values in the display with a slash above the measured value.
- offers 9 settings, for the
  - current averaging time (address 040),
  - power averaging time (address 041) and
  - voltage averaging time (address 042).

In the parameter addresses, the settings listed correspond to the following averaging times:

Parameter setting	Averaging time in seconds
0	5
1	10
2	30
3	60
4	300
5	480
6	900 (standard setting)
7	1800
8	3600

Tab. Averaging time settings

#### Averaging method

The exponential averaging method used achieves at least 95% of the measured value after the set averaging time.

### Min. and max. values

The device measures and calculates all measured values in all 10/12 periods. Min. and max. values are determined for most measured values.

The min. value is the smallest measured value that has been determined since the last deletion. The max. value is the largest measured value that has been determined since the last deletion.

All min. and max. values are compared with the associated measured values and are overwritten if fallen below or exceeded.

The device saves min. and max. values every 5 minutes in an EEPROM without the date and time. Therefore, in the event of a supply voltage failure, only the min. and max. values from the last 5 minutes can be lost.

#### 11.7.4 Deleting min. and max. values (parameter address 506)

If you configure the parameter address 506 with "001", all min. and max. values in the device are simultaneously deleted.

The max. value for the current mean value is an exception. The max. value for the current mean value can also be deleted directly in the display menu by pressing and holding key 2.

#### 11.7.5 Measured value display, automatic display change and changeover time (parameter address 037, 038, 039)

For a detailed description, see chap. „14. Measured value display and automatic display change profile“ on page 46.

#### 11.7.6 User password

#### (parameter address 050)

In order to protect already programmed or configured data, the device offers password protection. In the standard setting, the device does not have password protection.

Activating password protection:

In the parameter address 050, assign a password (settings 001-999).

Deactivating password protection:

Configure parameter address 050 with the setting 000.

Password entry with activated password protection:

- The password menu with the display "000" appears and you will only get into programming mode after entering the user password.
- The first number of the user password (the first "0") flashes.
- Using key 2, configure the desired first number.
- Using key 1, switch to the 2nd number.
- Configure the correct number combination for your user password correspondingly.
- After successful entry, you will arrive into programming mode for the current transformer.

Parameter setting	Description
000 .. 999	000 (no password - standard setting)

Tab. User password setting

#### Lost password

##### **NOTE**

Note your password and keep it in a safe place! If it is lost, the GridVis® software is required in order to reset the user password. Further information on connecting your device to a PC and the GridVis® software can be found in chap. „8. Connection“ on page 26.

### 11.7.7 Deleting the energy counter (parameter address 507)

The contents of the active energy, apparent energy and reactive energy counters for the device can only be deleted collectively. To delete the energy counter, configure parameter address 507 with "001".

Parameter setting	Description
0 .. 1	Deleting the energy counter - standard setting "0"

Tab. Deleting the energy counter

**ATTENTION**

**Property damage due to loss of data!**  
By deleting the energy counter contents (parameter address 507 = 1), this data in the device is lost!  
**Read and save the energy counter measured values with the GridVis® software before deleting the device contents!**

**NOTE**

Before commissioning, delete possible production-related contents of the energy counter and the min./max. values!

### 11.7.8 LCD contrast (parameter address 035)

The preferred viewing direction on the LCD display of the device is from "below". The following table shows the options for the LCD contrast settings:

Parameter setting	Description
0 .. 9	LCD contrast for the device display · 0 (low, characters very light). · 9 (high, characters very dark). · 4 (standard setting).

Tab. LCD contrast settings

### 11.7.9 Serial number (parameter address 911)

The serial number displayed by the device is

- 6 digits and a part of the serial number displayed on the rating plate.
- not changeable.

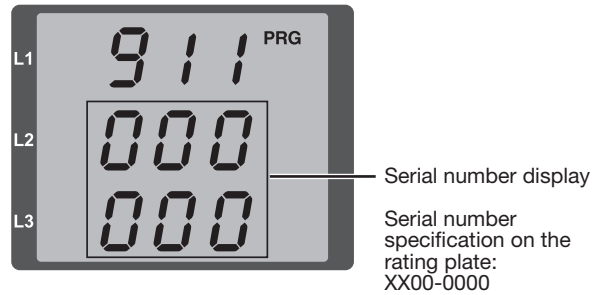



### 11.7.10 Software release (parameter address 913)

The device software (firmware) is continuously improved and expanded. The status of the device software is identified with a 3-digit number (software release).

The software release is not configurable.

#### **NOTE**

The device software (firmware) can be easily updated via the GridVis® network visualization software!

## 11.8 Important information for configuration

### 11.8.1 Energy counter

The device has an energy counter for active energy, apparent energy and reactive energy.

### 11.8.2 Reading the active energy

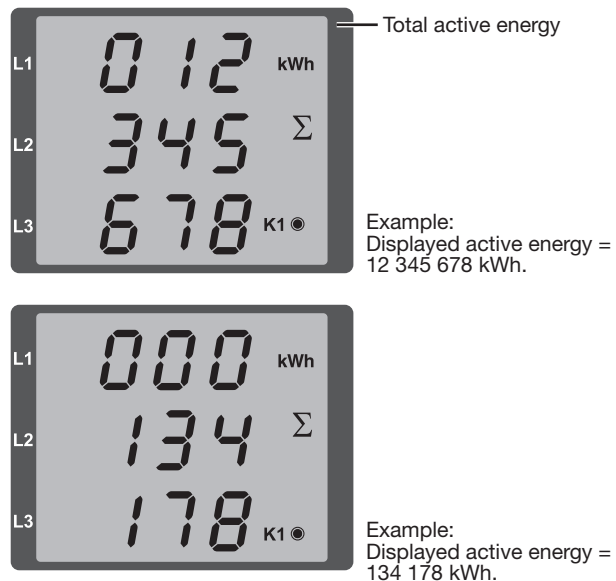

### 11.8.3 Harmonics and harmonics content

#### Harmonics

A harmonic is a harmonic vibration, the frequency of which is a whole multiple of a base frequency (mains frequency). The UMG 96-S2 requires a mains frequency of the voltage in the range of 45 to 65 Hz. The calculated harmonics of the voltages and currents relate to this mains frequency.

- The device records harmonics
- up to 15 times the mains frequency.
  - of the voltage in volts.
  - of the currents in amperes.

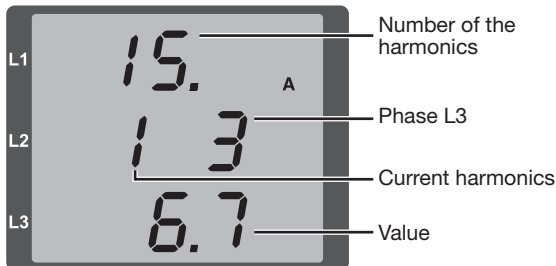

Fig. Example display of the 15th harmonics of the current in the phase L3

**NOTE**

The device only shows harmonics in the measured value display profile 2 (standard setting: measured value display 1)! See also chap. „14. Measured value display and automatic display change profile“ on page 46.

**Harmonics content THD**

The harmonics content THD is the ratio of the effective value of the harmonics to the effective value of the mains frequency.

Harmonics content of the current:

$$THD_I = \frac{1}{|I_{fund}|} \sqrt{\sum_{n=2}^M |I_{n.Harm}|^2}$$

Harmonics content of the voltage:

$$THD_U = \frac{1}{|U_{fund}|} \sqrt{\sum_{n=2}^M |U_{n.Harm}|^2}$$

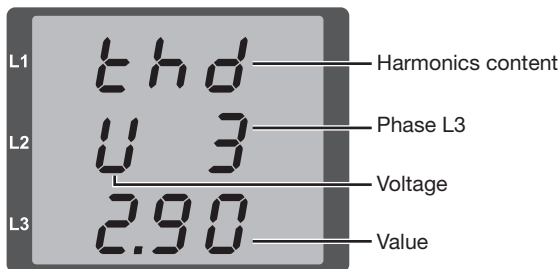

Fig. Example display of harmonics content THD of the voltage from the phase L3.

**11.8.4 Phase sequence**

The device presents the phase sequence of the voltages and the frequency of the phase L1 in one display.

The phase sequence indicates the phase order in three-phase networks. Normally a “right rotation field” exists. The phase order at the voltage measurement inputs is checked and displayed in the UMG 96-S2.

The device only determines the phase sequence if supply voltage and measured voltages are present.

A movement of the character string on the display clockwise means a “right rotation field” and movement counterclockwise means a “left rotation field”.

The phase sequence is not measured (the character string in the display is stationary) if

- a phase is missing or
- two identical phases are connected.



Example 1:  
Fig. Display of the mains frequency (50.0 Hz) and the phase sequence.



Example 2:  
Fig. No phase sequence determined.

**11.8.5 Operating hours counter**

The operating hours counter measures the time in which the device records and displays measured values.

The operating hours time is

- measured with a resolution of 0.1 h.
- displayed in hours.

The operating hours counter cannot be reset.

### **11.8.6 Backlight**

The backlight enables good legibility of the LCD display in poor visibility conditions.

The backlight is activated when a button is pressed or by a restart.

If no button is pressed for 5 minutes, the device switches off the display illumination. Pressing a button switches the backlight back on.

## 12. Commissioning

### 12.1 Connecting the supply voltage

- The supply voltage level for the device can be found on the rating plate or in chap. „18. Technical data“ on page 60.
- After connecting the supply voltage, the first measured value display appears on the device.
- If no display appears, check whether the supply voltage is within the rated voltage range.

### 12.2 Connecting the measured voltage

- Connect voltages in networks with rated voltages above 300 VAC to ground via a voltage transformer.
- Note that the measured voltages of all phases (L-N and L-L) displayed by the device are in realistic ranges in comparison to the actual measured voltages present. In the event of large deviations, check e.g. the set transformer ratios.

#### WARNING

##### High voltages and currents!

The rated voltages above 300 VAC to ground present on the device can lead to personal injuries and destroy the device.

- Connect voltages in networks with rated voltages above 300 VAC to ground via a voltage transformer.
- Do not exceed the threshold values specified in the user manual and on the rating plate! This must also be observed during inspections and commissioning.

### 12.3 Connecting the measured current

The device permits

- the connection of  $\approx 1$  A and  $\approx 5$  A current transformers.
- only the measurement of alternating currents via the current measurement inputs (no DC currents!).

When connecting the measured current, note that

- all current transformer outputs except for one are short circuited.
- the currents displayed by the device are in realistic ranges in comparison to the currents actually present. The current displayed by the device must correspond to the current input, taking in consideration the current transformer ratio.

- the device displays approx. 0 amperes in the short circuited current measurement inputs.
- if necessary, adjust the current transformer ratio to the current transformer used (standard setting: 5/5 A).

#### NOTE

The device is only suitable for the measurement of alternating voltages and currents! Do not connect DC currents!

### 12.4 Checking the phase sequence

Check the direction of the rotating field voltage in the measured value display of the device. Normally a “right” rotation field exists (for additional information, see chap.„12.8.4 Phase sequence“ on page 42).

### 12.5 Checking the phase assignment

The assignment of the phase conductor (phase) to the current transformer is correct if a current transformer is short circuited on the secondary side and the current displayed by the device in the associated phase conductor drops to 0 A.

### 12.6 Checking the power measurement

1. Short circuit all current transformer outputs except for one and check the powers displayed.
2. The device may only display a power in the phase conductor (phase) with the not short circuited current transformer output.
3. If this does not hold true, check the connections of the measured voltage and the measured current.

If the value of the measured active power is correct, but the sign is negative, this can have 2 causes:

1. Reversed connections S1(k) and S2(l) on the current transformer or
2. Active energy is delivered back into the network.

### 12.7 Checking the measurement

Correctly connected voltage and current measurement inputs produce correctly calculated and displayed individual and sum powers.

### 12.8 Checking the individual powers

If an incorrect phase conductor (phase) is assigned to a current transformer, the associated power is incorrectly measured and displayed.

The phase conductor and current transformer are correctly assigned on the device if there is no voltage present between the phase conductor and the associated current transformer (primary).

To ensure that a phase conductor is assigned to the correct current transformer at the voltage measurement input, the respective current transformer can be short circuited on the secondary side. The apparent power displayed by the device must then be zero in this phase conductor (phase).

If the apparent power is displayed correctly, but the active power is displayed with a negative ("-") sign, then the current transformer terminals are reversed or power is being delivered to the energy supply company.

### 12.9 Checking the sum powers

If all voltages, currents and powers are correctly displayed for the respective phase conductor, the sum powers measured by the device are also correct. For confirmation, compare the sum powers measured by the device with the work of the active and reactive power counter located in the supply.

### 13. Measured value display and automatic display change profile

#### 13.1 Measured value displays

After a return of power, the device shows the first measured value display from the measured value display profile 1 (standard setting).

In order to keep the selection of measured value displays manageable, the device sorts the measured value displays and thus the measured values into profiles.

The device provides 3 measured value display profiles with different arrangements of measured value displays. The measured value display profile is selected in the parameter address 037.

The measured values included in the measured value display profiles appear one by one when the key is pressed.

#### Measured value display profile (parameter address 037)

Parameter setting	Profiles
0	Measured value display profile 1 (standard setting).
1	Measured value display profile 2.
2	Measured value display profile 3.

Tab. Profile setting

**NOTE**

An overview of the measured value display profiles can be found in chap. „14.4 Overview of measured value displays - display profile 1-3“ on page 48.

#### 13.2 Automatic display change profile

All measured value displays can be called up by the device once per second. Alternatively to the measured value display profile mentioned above and calling up the measured values by pressing a key, an automatically changing measured value display can also be set on the device.

In order to keep the selection of measured values manageable, the device also sorts the measured values for the automatic display change into profiles.

To activate the automatic display change profile, program a changeover time >0 in the parameter address 039 of the device.

If a key is pressed between the automatic display change, the next measured value display stored in the profile appears. If the key is pressed repeatedly, you will scroll between the measured values stored in the selected display change profile.

If no key is pressed for 60 s, the device switches back to the automatic display change.

#### Changeover time (parameter address 039)

Parameter setting	Changeover time
0	Automatic display change deactivated (standard setting).
1 .. 60	Changeover time in seconds. Applies for all automatic display change profiles.

Tab. Automatic changeover time setting

#### Display change profile (parameter address 038)

Parameter setting	Display change profile
0	Measured value display profile 1 (standard setting).
1	Measured value display profile 2.
2	Measured value display profile 3.

Tab. Display change profile setting

**NOTE**

An overview of the automatic display change profiles can be found in chap. „14.5 Overview of automatic display change profiles 1-3“ on page 52.

#### 13.3 Select measured value display profiles in the GridVis® software

The GridVis® software offers a clear presentation and the option to choose between measured value display profiles.

In order to use the GridVis® software, connect your device to a PC via the serial interface (RS485) (see chap. „8. Connection“ on page 26).



### 13.4 Overview of measured value displays - display profile 1-3

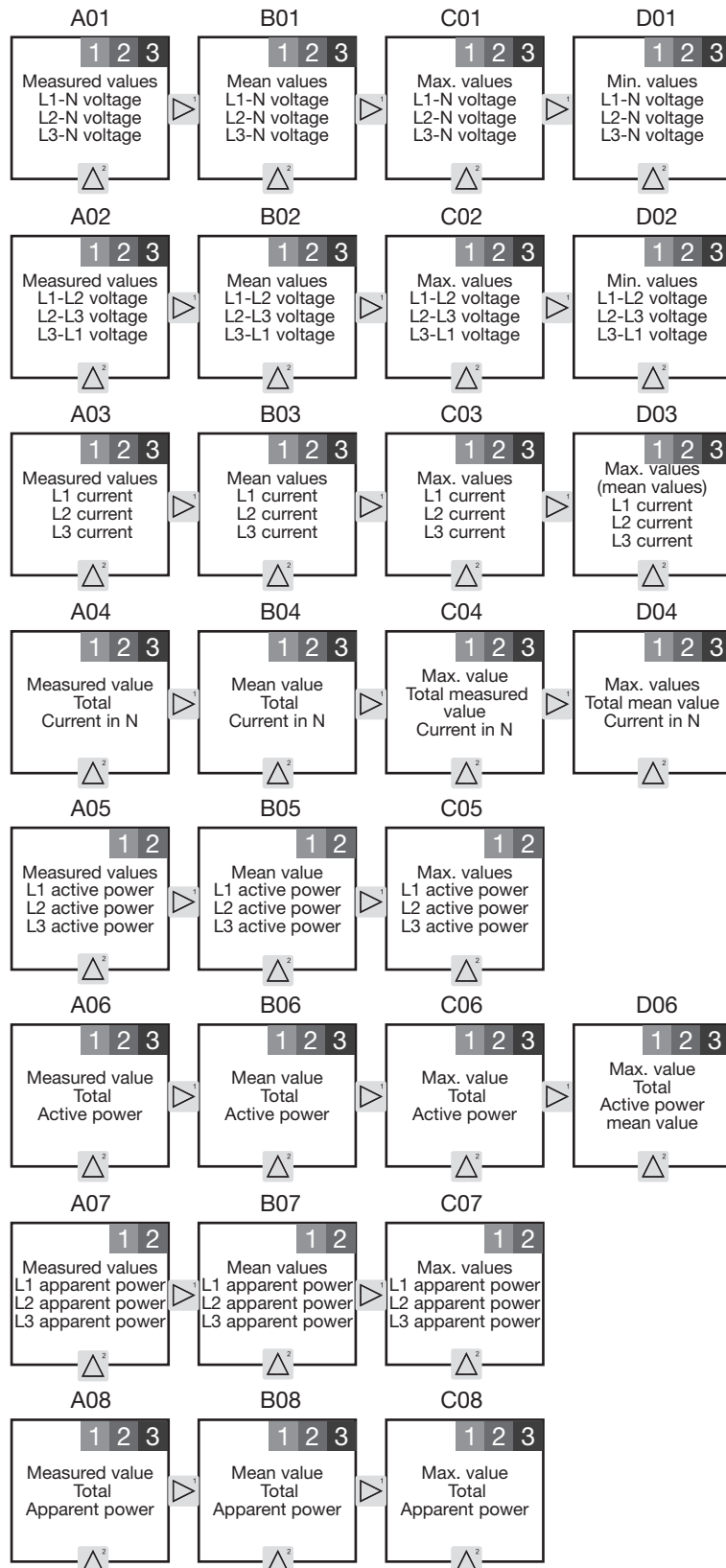



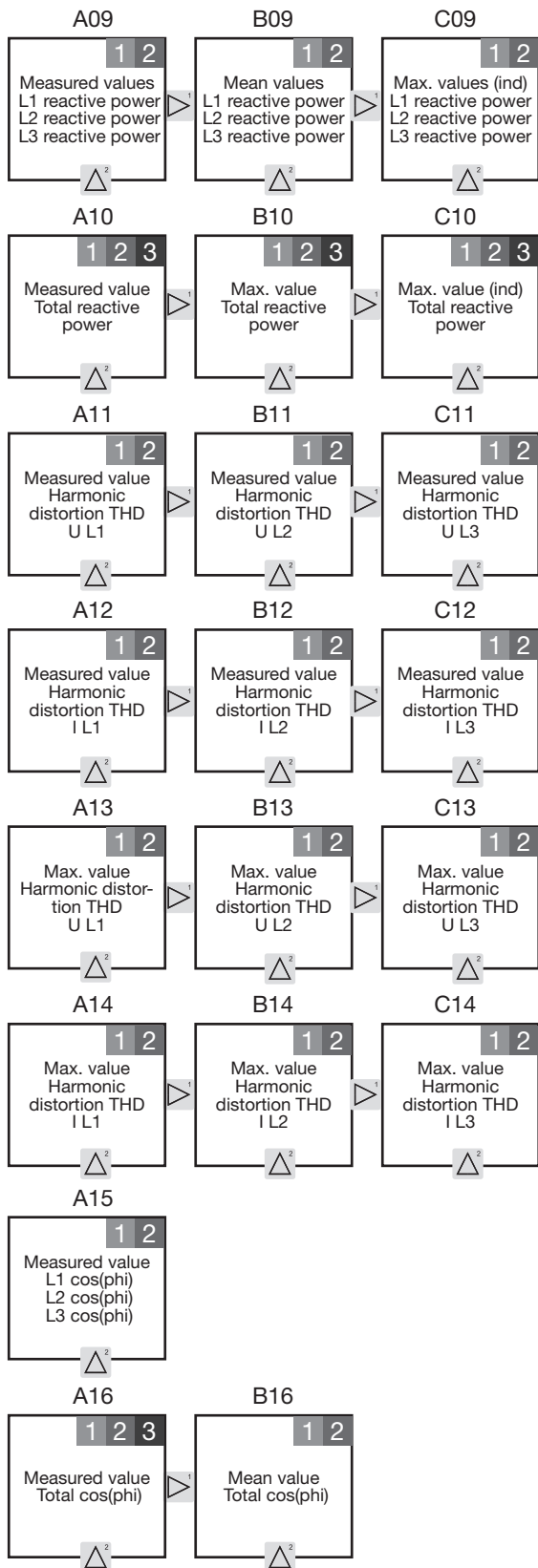

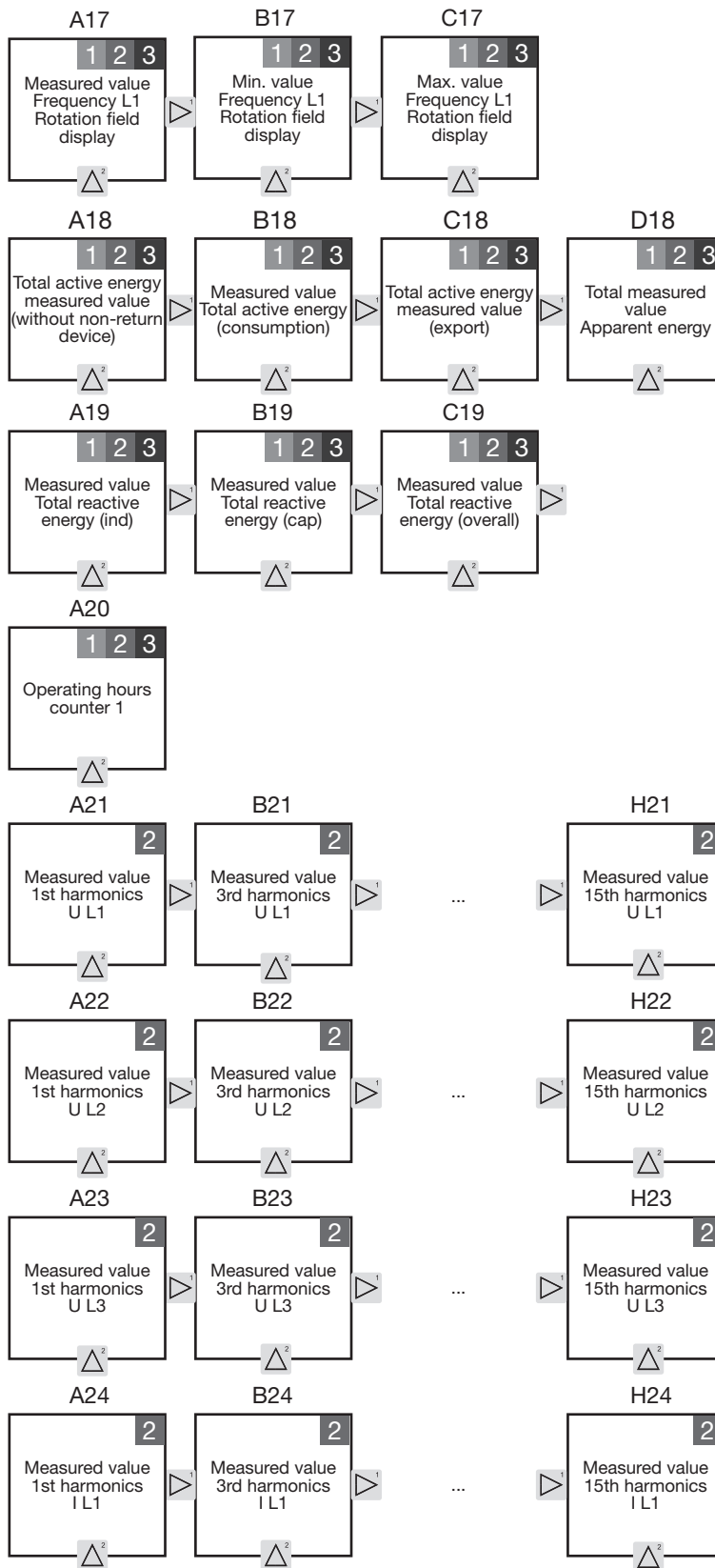

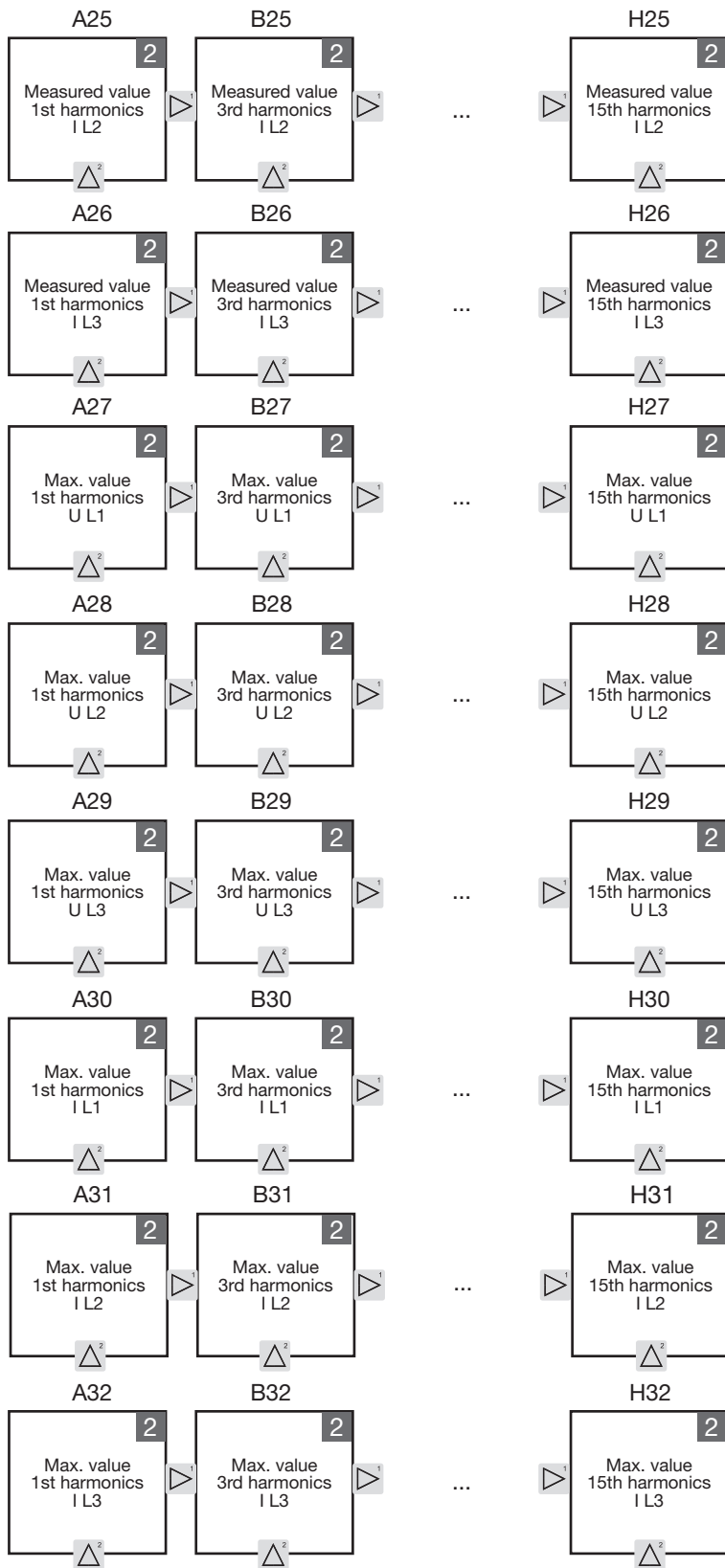

### 13.5 Overview of automatic display change profiles 1-3

**NOTE**

Please note!

- The measured value displays change depending on the set changeover time (parameter address 039).
- The display change profiles do not include all measured value displays! The measured values displayed in the respective profile are presented below.

A01

1 2 3

Measured values  
L1-N voltage  
L2-N voltage  
L3-N voltage

A02

2

Measured values  
L1-L2 voltage  
L2-L3 voltage  
L3-L1 voltage

A03

1 2 3

Measured values  
L1 current  
L2 current  
L3 current

A04

2

Measured value  
Total  
Current in N

A05

2 3

Measured values  
L1 active power  
L2 active power  
L3 active power

A06

1 2 3

Measured value  
Total  
Active power

A07

2

Measured values  
L1 apparent power  
L2 apparent power  
L3 apparent power

A10

1

Measured value  
Total reactive  
power

A16

1 2 3

Measured value  
Total cos(phi)

A17

1 2

Measured value  
Frequency L1  
Rotation field  
display

A18

1 2

Total active energy  
measured value  
(without non-return  
device)

A19

1 2

Measured value  
(ind)  
Reactive energy

A20

2

Operating hours  
counter 1

A21

2

Measured value  
1st harmonics  
U L1

A22

2

Measured value  
1st harmonics  
U L2

A23

2

Measured value  
1st harmonics  
U L3

B18

1 2

Measured value  
Total active energy  
(consumption)

C18

1 2

Total active energy  
measured value  
(export)

A24

2  
Measured value  
1st harmonics  
I L1

A25

2  
Measured value  
1st harmonics  
I L2

A26

2  
Measured value  
1st harmonics  
I L3

### 14. Connection example

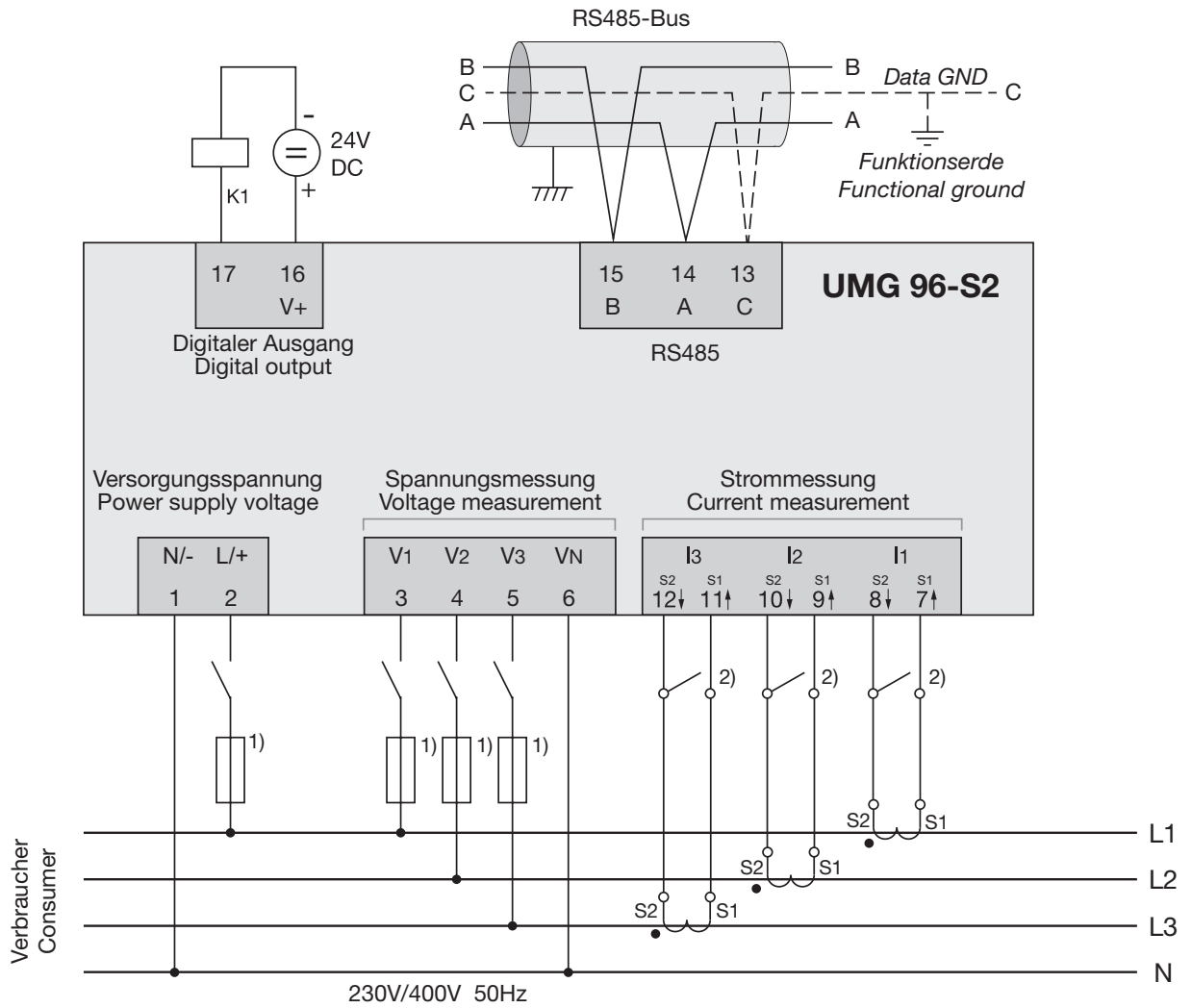

Fig. Connection example for UMG 96-S2

1) UL/IEC approved fuse protection

2) Jumpers (external)



## 15. Service and maintenance

The device is subject to various safety tests prior to delivery and marked with a seal. If a device is opened, the safety tests must be repeated. A warranty is only assumed for unopened devices.

### 15.1 Repair and calibration

Repair and calibration of the device may only be carried out by the manufacturer.

The manufacturer recommends having a calibration of the device performed by the manufacturer itself or by an accredited laboratory at 5-year intervals.

#### **WARNING**

##### **Warning against impermissible manipulations or improper use of the device.**

Opening, dismantling or impermissible manipulation of the device, which exceeds the specified mechanical, electrical or other operating limits, can result in property damage or injuries up to death.

- Only electrically qualified personnel may work on the devices and their components, assemblies, systems and circuits!
- Always use your device or components as described in the associated documentation.
- Send the device back to the manufacturer in the event of visible damage, and also for repair and calibration!

### 15.2 Front film and display

Observe the following during the care and cleaning of the front film and display:

#### **ATTENTION**

##### **Property damage due to incorrect care and cleaning of the device.**

The use of water or other solvents, such as e.g. denatured alcohol, acids, acidic agents, for the front film or the display can damage or destroy the device during the cleaning. Water can e.g. penetrate the device housing and destroy the device.

- Clean the device, front film or the display with a soft cloth.
- For severe soiling, use a cloth moistened with clear water.
- Clean the front film and the display, e.g. fingerprints, with a special LCD cleaner and a lint-free cloth.
- Do not use any acids or acidic agents to clean the devices.

### 15.3 Device adjustment

The manufacturer adjusted the devices before delivery. When adhering to the ambient conditions, a readjustment is not necessary.

### 15.4 Firmware update

A firmware update for your device is executed with the GridVis® software. The GridVis® software is available on our web site as a download.

### 15.5 Service

In case of any questions which are not described in this user manual, please contact the manufacturer. Please have the following information ready:

- Device designation (rating plate).
- Serial number (rating plate).
- Software release (see measured value display).
- Measured voltage and supply voltage.
- Exact error description.



## 16. Error messages

In the event of errors, the device has 3 types of error messages:

- Warnings.
- Serious errors.
- Measurement range exceeded.

With warnings and serious errors, the error message "EEE" appears, followed by an error number:

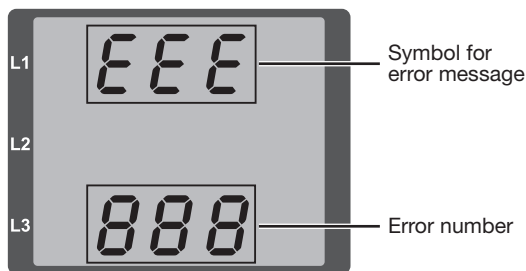

Fig. Display with error message and error number.

The 3-digit error message gives an indication of the error cause, if identifiable by the device, and supplies an error description for this:

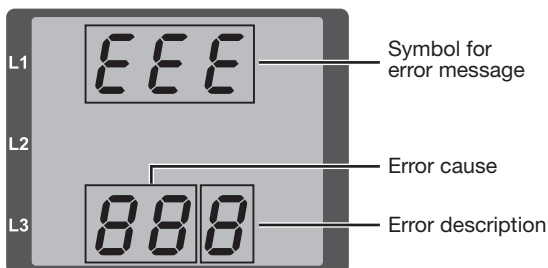

Fig. Display with error message and error number (split into error cause and error description).

### Example of error message 911:

The error number in this case is composed of the serious error **910** and the internal error **0x01**:

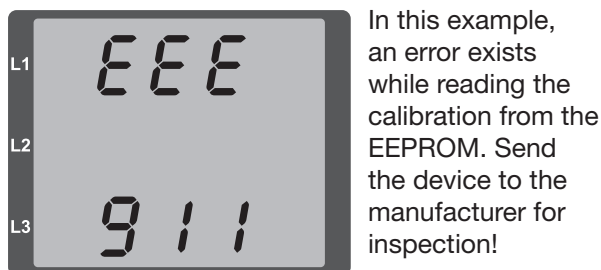

Fig. Example: Display with error message

### 16.1 Warnings

Warnings are errors that can be acknowledged via key 1 or key 2.

The recording and display of measured values still runs.

Error	Error description
EEE 500	The device does not determine any mains frequency! Causes: · The voltage at L1 is too low or there is no voltage present. · The mains frequency is outside of the frequency range (45 - 65 Hz). This error appears again after each voltage recovery.

### 16.2 Serious errors

Send the device to the manufacturer for inspection!

Error	Error description
EEE 910	Error while reading the calibration.

### 16.3 Internal error cause recognition

In some cases, the device recognizes the causes for an error and can report these via an error code. Send the device to the manufacturer for inspection!

Dis- played error number	Error code	Error description
911	0x01	EEPROM is not answering.

### 16.4 Exceeding the measurement range

- A measurement range exceedance
- exists when at least one of the three voltage or current measurement inputs are outside of the threshold values for the metering range.
  - appears as long as it continues and cannot be acknowledged.

An arrow “upward” marks the respective phase in which the measurement range exceedance exists.

The unit “V” for voltage and “A” for current shows whether the measurement range exceedance exists in the voltage circuit or current path.

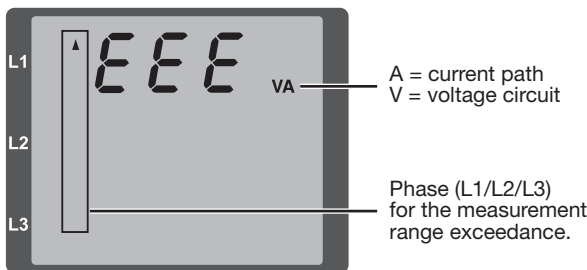

Fig. Display with measurement range exceedance

#### Threshold values for the measurement range exceedance:

$$I = 7 A_{eff}$$

$$U_{L-N} = 300 V_{rms}$$

#### Examples

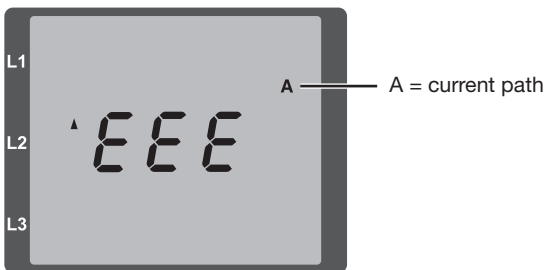

Fig. Display of measurement range exceedance in the current path of the 2nd phase (I2).

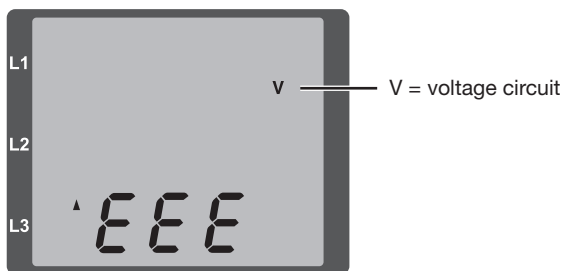
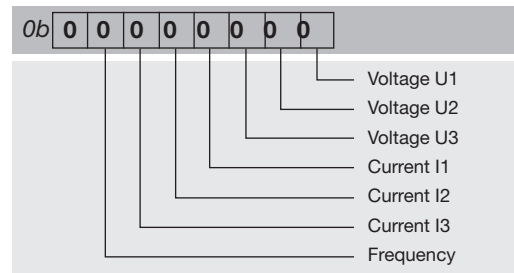

Fig. Display of measurement range exceedance in the voltage circuit L3.

### 16.5 Measurement range exceedance parameter

A coded error description is in the measurement range exceedance parameter (address 600) in the following format:



#### Example 1

Error in the current path I of phase 2:

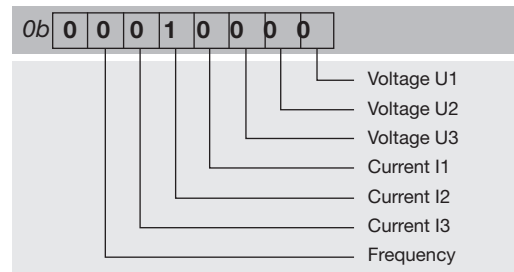

#### Example 2

Error in the voltage circuit U<sub>L-N</sub> of phase 3:

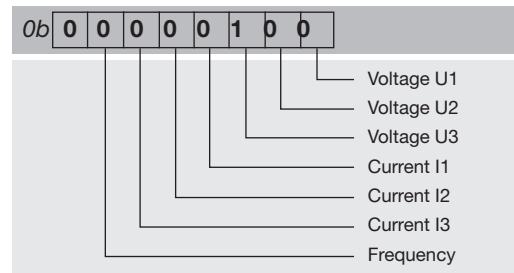

## 16.6 Procedure in the event of errors

Possible error	Cause	Remedy
No display	External fuse for the power supply voltage has tripped.	Replace fuse.
No current display	Measured voltage is not connected.	Connect the measured voltage.
	Measurement current is not connected.	Connect measurement current.
Current displayed is too large or too small.	Current measurement in the wrong phase.	Check connection and correct if necessary.
	Current transformer factor is incorrectly programmed.	Read out and program the current transformer transformation ratio at the current transformer.
	Current harmonics exceed the current peak value at the measurement input	Install current transformer with a larger CT ratio.
Voltage displayed is too large or too small.	The current at the measurement input was not achieved.	Install current transformer with a smaller current transformer ratio.
	Measurement in the wrong phase.	Check connection and correct if necessary.
Voltage displayed is too large or too small.	Voltage transformer incorrectly programmed.	Read out and program the voltage transformer ratio at the voltage transformer.
	Measurement range exceeded.	Install voltage transformers.
Voltage displayed is too small.	The peak voltage value at the measurement input has been exceeded by harmonic components.	<b>Attention!</b> Ensure the measurement inputs are not overloaded.
	Phase shift ind/cap.	Current path is assigned to the wrong voltage circuit.
Active power is too large or too small. *	Current path is assigned to the wrong voltage circuit.	Check connection and correct if necessary.
	The programmed voltage transformer ratio is incorrect	Read the current transformer ratio on the current transformer and configure it again on the device.
	The programmed voltage transformer ratio is incorrect	Read the voltage transformer ratio on the voltage transformer and configure it again on the device.
Active power consumption/export is reversed.	At least one current transformer connection is reversed.	Check connection and correct if necessary.
	A current path is assigned to the wrong voltage circuit.	Check connection and correct if necessary.
An output is not responding.	Incorrectly connected output.	Check connection and correct if necessary.
"StG onE" in the display	Firmware update failed.	Renew firmware update via the GridVis® software.
"EEE" in the display	See error messages.	
No connection to the device.	Incorrect device address	Correct device address.
	Different bus speeds (baud rate)	Correct speed (baud rate).
	Incorrect protocol.	Correct protocol.
	Termination missing.	Connect bus with termination resistor.
Device still does not work despite the above measures.	Device defective.	Send the device to the manufacturer for inspection and testing.

\* If the max. total energy value is reached, the display "0" appears.

### NOTE

#### Property damage due to overloaded measurement inputs!

Too high current and voltage values overload the measurement inputs and can damage the device.

**Observe the threshold values specified on the rating plate and in the technical data of this manual.**

## 17. Technical data

General information	
Net weight (with attached connectors)	Approx. 250 g (0.55 lb)
Packaging weight (including accessories)	Approx. 500 g (1.10 lb)
Impact resistance	IK07 according to IEC 62262
Transport and storage	
The following information applies to devices which are transported and stored in the original packaging.	
Free fall	1 m (39.37 in)
Temperature	K55, -25 °C (-13 °F) up to +70 °C (158 °F)
Relative humidity	0 to 90% RH
Ambient conditions during operation	
Use the UMG 96-S2 in a weather-protected, stationary application. Protection class II in accordance with IEC 60536 (VDE 0106, Part 1).	
Operating temperature range	K55, -10° C (14 °F) .. +55° C (131 °F)
Relative humidity	0 to 75% RH
Operating altitude	0 .. 2000 m (1.24 mi) above sea level
Degree of pollution	2
Installation position	discretionary
Ventilation	no external ventilation required
Protection against foreign bodies and water	
- Front	IP40 i.a.w. EN60529
- Rear	IP20 i.a.w. EN60529
- Front side with sealing	IP54 i.a.w. EN60529
Supply voltage	
Nominal range	AC 90 V - 265 V (50/60 Hz) or DC 90 V - 250 V, 300 V CATIII
Operating range	+/-10% of nominal range
Power consumption	max. 1.5 VA / 0.5 W
Internal fuse, not exchangeable	Type T1A / 250 VDC / 277 VAC according to IEC 60127
Recommended overcurrent protection device for the line protection	6-16 A (Char. B, IEC-/UL approval)
Voltage measurement	
Three-phase 4-conductor systems with nominal voltages up to	230 V/400 V (+/-10%) according to IEC
Overvoltage category	300 V CAT III
Measurement voltage surge	4 kV
Fuse for the voltage measurement	1 - 10 A (with IEC/UL approval)
Measuring range L-N	0 <sup>1)</sup> .. 300 Vrms (max. overvoltage 400 Vrms)
Measuring range L-L	0 <sup>1)</sup> .. 425 Vrms (max. overvoltage 620 Vrms)
Measurement range exceedance L-N	$U_{L-N} > 300 \text{ Vrms}$
Resolution	0.01 V
Crest factor	1.9 (related to the measurement range)
Impedance	3 MΩ/phase
Power consumption	Approx. 0.1 VA
Sampling frequency	8 kHz
Frequency of the basic oscillation	45 Hz .. 65 Hz
- resolution	0.01 Hz

1) The device only determines the measured values if voltage L1-N is greater than 20 Veff (4-conductor measurement) or voltage L1-L2 is greater than 34 Veff (3-conductor measurement) on voltage measurement input V1.

### Current measurement

Rated current	x/1 and x/5 A
Metering range	0.005 .. 6 Arms
Measurement range exceedance	I > 7 Arms
Crest factor (based on the rated current)	2
Resolution	1 mA (display 0.01 A) at ..5 A 1/4 mA at ..1 A
Overvoltage category	300 V CAT II
Measurement voltage surge	2 kV
Power consumption	approx. 0.2 VA (Ri=5 mΩ)
Overload for 1 s	60 A (sinusoidal)
Sampling frequency	8 kHz

**Serial interface**

RS485 - Modbus RTU/slave	9.6 kbps, 19.2 kbps, 38.4 kbps
--------------------------	--------------------------------

**Digital output**

1 digital output, semiconductor relay, not short-circuit proof.

Switching voltage	max. 60 V DC
Switching current	max. 50 mAeff DC
Pulse output (energy pulse)	Max. 12.5 Hz

**Terminal connection capacity (supply voltage)**

Connectable conductor (Connect only one conductor per terminal!):

Single core, multi-core, fine-stranded	0.2 - 4 mm <sup>2</sup> , AWG 28-12
Cable end sleeve (not insulated)	0.2 - 4 mm <sup>2</sup> , AWG 26-12
Cable end sleeve (insulated)	0.2 - 2.5 mm <sup>2</sup> , AWG 26-14
Tightening torque	0.4 - 0.5 Nm (3.54-4.43 lbf in)
Stripping length	7 mm (0.2756 in)

**Terminal connection capacity (voltage measurement)**

Connectable conductor (Connect only one conductor per terminal!):

Single core, multi-core, fine-stranded	0.2 - 4 mm <sup>2</sup> , AWG 28-12
Cable end sleeve (not insulated)	0.2 - 2.5 mm <sup>2</sup> , AWG 26-14
Cable end sleeve (insulated)	0.2 - 2.5 mm <sup>2</sup> , AWG 26-14
Tightening torque	0.4 - 0.5 Nm (3.54-4.43 lbf in)
Stripping length	7 mm (0.2756 in)

**Terminal connection capacity (current measurement)**

Connectable conductor (Connect only one conductor per terminal!):

Single core, multi-core, fine-stranded	0.2 - 4 mm <sup>2</sup> , AWG 28-12
Cable end sleeve (not insulated)	0.2 - 4 mm <sup>2</sup> , AWG 26-12
Cable end sleeve (insulated)	0.2 - 2.5 mm <sup>2</sup> , AWG 26-14
Tightening torque	0.4 - 0.5 Nm (3.54-4.43 lbf in)
Stripping length	7 mm (0.2756 in)

**Terminal connection capacity (digital interface)**

Single core, multi-core, fine-stranded	0.2 - 1.5 mm <sup>2</sup> , AWG 28-16
Cable end sleeve (not insulated)	0.2 - 1.5 mm <sup>2</sup> , AWG 26-16
Cable end sleeve (insulated)	0.2 - 1.5 mm <sup>2</sup> , AWG 26-16
Tightening torque	0.2 - 0.25 Nm (1.77-2.21 lbf in)
Stripping length	7 mm (0.2756 in)

**Terminal connection capacity (serial interface)**

Single core, multi-core, fine-stranded	0.2 - 1.5 mm <sup>2</sup> , AWG 28-16
Cable end sleeve (not insulated)	0.2 - 1.5 mm <sup>2</sup> , AWG 26-16
Cable end sleeve (insulated)	0.2 - 1.5 mm <sup>2</sup> , AWG 26-16
Tightening torque	0.2 - 0.25 Nm (1.77-2.21 lbf in)
Stripping length	7 mm (0.2756 in)

## 17.1 Function characteristics

Function	Symbol	Accuracy class	Metering range	Display range
Total active power	P	0.5 <sup>5)</sup> (IEC61557-12)	0 W .. 5.4 kW	0 W .. 999 GW *
Total reactive power	QA, Qv	1 (IEC61557-12)	0 var .. 5.4 kvar	0 var .. 999 Gvar *
Total apparent power	SA, Sv	0.5 <sup>5)</sup> (IEC61557-12)	0 VA .. 5.4 kVA	0 VA .. 999 GVA *
Total active energy	Ea	0.5 <sup>5)</sup> (IEC61557-12) 0.5S <sup>5)</sup> (IEC62053-22)	0 Wh .. 999 GWh	0 Wh .. 999 GWh *
Total reactive energy	ErA, ErV	1 (IEC61557-12)	0 varh .. 999 Gvarh	0 varh .. 999 Gvarh *
Total apparent energy	EapA, EapV	0.5 <sup>5)</sup> (IEC61557-12)	0 VAh .. 999 GVAh	0 VAh .. 999 GVAh *
Frequency	f	0.05 (IEC61557-12)	45 Hz .. 65 Hz	45.00 Hz .. 65.00 Hz
Phase current	I	0.2 (IEC61557-12)	0.005 Arms .. 6 Arms	0 A .. 999 kA
Calculated neutral conductor current	INc	1.0 (IEC61557-12)	0.03 A.. 25 A	0.03 A .. 999 kA
Voltage	U L-N	0.2 (IEC61557-12)	10 Vrms..300 Vrms	0 V .. 999 kV
Voltage	U L-L	0.2 (IEC61557-12)	18 Vrms..620 Vrms	0 V .. 999 kV
Power factor	PFA, PFV	0.5 (IEC61557-12)	0.00 .. 1.00	0.00 .. 1.00
Short-term flicker, long-term flicker	Pst, Plt	-	-	-
Voltage dips (L-N)	Udip	-	-	-
Voltage swells (L-N)	Uswl	-	-	-
Transient voltage swells	Utr	-	-	-
Voltage interruptions	Uint	-	-	-
Voltage unbalance (L-N) <sup>1)</sup>	Unba	-	-	-
Voltage unbalance (L-N) <sup>2)</sup>	Unb	-	-	-
Voltage harmonics	Uh	Cl. 1 (IEC61000-4-7)	1 .. 15 (only odd)	0 V .. 999 kV
THD of the voltage <sup>3)</sup>	THDu	1.0 (IEC61557-12)	0 % .. 999 %	0 % .. 999 %
THD of the voltage <sup>4)</sup>	THD-Ru	-	-	-
Current harmonics	Ih	Cl. 1 (IEC61000-4-7)	1 .. 15 (only odd)	0 A .. 999 kA
THD of the current <sup>3)</sup>	THDi	1.0 (IEC61557-12)	0 % .. 999 %	0 % .. 999 %
THD of the current <sup>4)</sup>	THD-Ri	-	-	-
Mains signal voltage	MSV	-	-	-

1) In relation to the amplitude.

2) In relation to the phase and amplitude.

3) In relation to the mains frequency.

4) In relation to the effective value.

5) Accuracy class 0.5/0.5S with ../5A transformer.  
Accuracy class 1 with ../1A transformer.

\* If the max. total energy value is reached, the display "0" appears.



## 17.2 Parameter and Modbus address list

The parameter list (table 1) contains the settings for the correct operation of the device, such as e.g. current transformer and device addresses. The values for the parameter list can be described and read.

The Modbus address list (table 2) contains measured and calculated measured values, condition data for the outputs and logged values for reading out.

### NOTE

- A complete overview of the parameter list and the Modbus address list with explanations for the selected measured values can be found in the document "Modbus address list" in the download area on our web site.
- The addresses listed in the parameter list (up to address 800) are configured on the device.
- From address 1000, the addresses are configured via the Modbus address list

## 17.3 Table 1 - Parameter list

Address	Format	RD/WR	Unit	Remark	Setting range	Default setting
0	SHORT	RD/WR	-	Device address	0..255 <sup>(*)</sup>	1
1	SHORT	RD/WR	kbps	Baud rate (0 = 9.6 kbps, 1 = 19.2 kbps, 2 = 38.4 kbps)	0..2	2
2	SHORT	RD/WR	-	Stop bits 0 = 1 bit, parity none 1 = 2 bits, parity none 2 = 1 bit, parity even 3 = 1 bit, parity odd	0..3	0
10	FLOAT	RD/WR	A	Current transformer I1.. I3, primary	0..1000000 <sup>(**)</sup>	5
12	FLOAT	RD/WR	A	Current transformer I1.. I3, secondary	1..5	5
14	FLOAT	RD/WR	V	Voltage transformer V1..V3, primary	0..1000000 <sup>(**)</sup>	400
16	FLOAT	RD/WR	V	Voltage transformer V1..V3, secondary	100, 400	400
35	SHORT	RD/WR	-	Contrast of the display, 0 (low), 9 (high)	0..9	4
37	SHORT	RD/WRw	-	Display profile 0 = configured display profile 1 1 = configured display profile 2 2 = configured display profile 3	0..2	0
38	SHORT	RD/WR	-	Display change profile 0 = configured display change profile 1 1 = configured display change profile 2 2 = configured display change profile 3	0..2	0
39	SHORT	RD/WR	s	Changeover time	0..60	0
40	SHORT	RD/WR	-	Averaging time, I	0..8 *	6
41	SHORT	RD/WR	-	Averaging time, P	0..8 *	6
42	SHORT	RD/WR	-	Averaging time, U	0..8 *	6
43	USHORT	RD/WR	mA	Current measurement response threshold	0..200	5
50	SHORT	RD/WR	-	Password	0..999	0 (no password)
100	SHORT	RD/WR	-	Digital output 1 (pulse output) 0 = P (active energy) 1 = Q (reactive energy) 2 = S (apparent energy) 3 = OFF	0..3	0
102	FLOAT	RD/WR	imp / kWh	Pulse value, digital output 1	-1000000..+1000000	1000
106	SHORT	RD/WR	ms	Minimum pulse length	10..1000	50
506	SHORT	RD/WR	-	Delete min. and max. values	0, 1	0
507	SHORT	RD/WR	-	Delete the energy counter	0, 1	0
508	SHORT	RD/WR	-	Force EEPROM describing	0, 1	0
911	SERNR	RD	-	Serial number		
913	SHORT	RD	-	Software release		
914	SERNR	RD	-	Production number		

<sup>(\*)</sup> The values 0 and 248 to 255 are reserved and may not be used.

<sup>(\*\*)</sup> The adjustable value "0" does not yield a reasonable operating value and may not be used.

\* 0 = 5 sec.; 1 = 10 sec.; 2 = 30 sec.; 3 = 1 min.; 4 = 5 min.; 5 = 8 min.; 6 = 15 min.; 7 = 30 min.; 8 = 60 min.



**17.4 Table 2 - Modbus address list**  
(excerpt of the frequently required measured values)

Modbus address	Address via display	Format	RD/WR	Unit	Remark
19000	808	float	RD	V	Voltage, L1-N
19002	810	float	RD	V	Voltage, L2-N
19004	812	float	RD	V	Voltage, L3-N
19006	814	float	RD	V	Voltage, L1-L2
19008	816	float	RD	V	Voltage, L2-L3
19010	818	float	RD	V	Voltage, L3-L1
19012	860	float	RD	A	Current, L1
19014	862	float	RD	A	Current, L2
19016	864	float	RD	A	Current, L3
19018	866	float	RD	A	Total; $IN=I1+I2+I3$
19020	868	float	RD	W	Active power L1
19022	870	float	RD	W	Active power L2
19024	872	float	RD	W	Active power L3
19026	874	float	RD	W	Total; $Psum3=P1+P2+P3$
19028	884	float	RD	VA	Apparent power S L1
19030	886	float	RD	VA	Apparent power S L2
19032	888	float	RD	VA	Apparent power S L3
19034	890	float	RD	VA	Total; $Ssum3=S1+S2+S3$
19036	876	float	RD	var	Fund. reactive power (mains frequency) Q L1
19038	878	float	RD	var	Fund. reactive power (mains frequency) Q L2
19040	880	float	RD	var	Fund. reactive power (mains frequency) Q L3
19042	882	float	RD	var	Total; $Qsum3=Q1+Q2+Q3$
19044	820	float	RD	-	Fund. power factor, CosPhi; U L1-N IL1
19046	822	float	RD	-	Fund. power factor, CosPhi; U L2-N IL2
19048	824	float	RD	-	Fund. power factor, CosPhi; U L3-N IL3
19050	800	float	RD	Hz	Frequency
19052	-	float	RD	-	Rotation field; 1=right, 0=none, -1=left
19054	-	float	RD	Wh	Active energy L1
19056	-	float	RD	Wh	Active energy L2
19058	-	float	RD	Wh	Active energy L3
19060	-	float	RD	Wh	Active energy L1..L3
19062	-	float	RD	Wh	Active energy L1, obtained
19064	-	float	RD	Wh	Active energy L2, obtained
19066	-	float	RD	Wh	Active energy L3, obtained
19068	-	float	RD	Wh	Active energy L1..L3, consumed, rate 1
19070	-	float	RD	Wh	Active energy L1, supplied
19072	-	float	RD	Wh	Active energy L2, supplied
19074	-	float	RD	Wh	Active energy L3, supplied
19076	-	float	RD	Wh	Active energy L1..L3, supplied
19078	-	float	RD	VAh	Apparent energy L1
19080	-	float	RD	VAh	Apparent energy L2
19082	-	float	RD	VAh	Apparent energy L3
19084	-	float	RD	VAh	Apparent energy L1..L3
19086	-	float	RD	varh	Reactive energy L1
19088	-	float	RD	varh	Reactive energy L2
19090	-	float	RD	varh	Reactive energy L3
19092	-	float	RD	varh	Reactive energy L1..L3
19094	-	float	RD	varh	Reactive energy, inductive, L1
19096	-	float	RD	varh	Reactive energy, inductive, L2
19098	-	float	RD	varh	Reactive energy, inductive, L3
19100	-	float	RD	varh	Reactive energy, inductive, L1..L3
19102	-	float	RD	varh	Reactive energy, capacitive, L1
19104	-	float	RD	varh	Reactive energy, capacitive, L2

Modbus address	Address via display	Format	RD/WR	Unit	Remark
19106	-	float	RD	varh	Reactive energy, capacitive, L3
19108	-	float	RD	varh	Reactive energy, capacitive, L1..L3
19110	836	float	RD	%	Harmonic, THD, U L1-N
19112	838	float	RD	%	Harmonic, THD, U L2-N
19114	840	float	RD	%	Harmonic, THD, U L3-N
19116	908	float	RD	%	Harmonic, THD, I L1
19118	910	float	RD	%	Harmonic, THD, I L2
19120	912	float	RD	%	Harmonic, THD, I L3

### 17.5 Number formats

Type	Size	Minimum	Maximum
short	16 bit	$-2^{15}$	$2^{15} - 1$
ushort	16 bit	0	$2^{16} - 1$
int	32 bit	$-2^{31}$	$2^{31} - 1$
uint	32 bit	0	$2^{32} - 1$
float	32 bit	IEEE 754	IEEE 754

### 17.6 Note on saving measured values and configuration data

#### NOTE

#### Note on saving measured values and configuration data:

- Since the following measured values are saved in a non-volatile memory every 5 minutes, the recording may **be interrupted for** a maximum of 5 minutes in case the operating voltage fails:
  - Comparator timer
  - S0 counter statuses
  - Min. / Max. / mean values (without the date and time)
  - Energy values
- Configuration data is saved immediately.

A detailed Modbus address and parameter list can be found at [www.janitza.com](http://www.janitza.com)

### 18. Dimensional drawings

- All specifications in mm.
- The figures serve as illustrations and are not true to scale.

**Rear view**

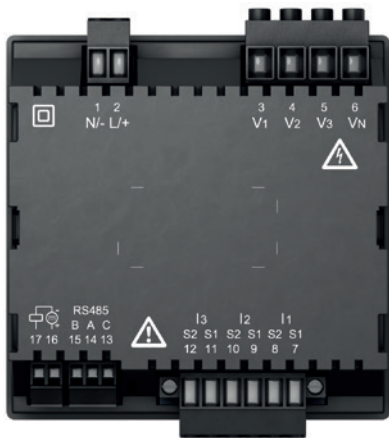

**Side view**

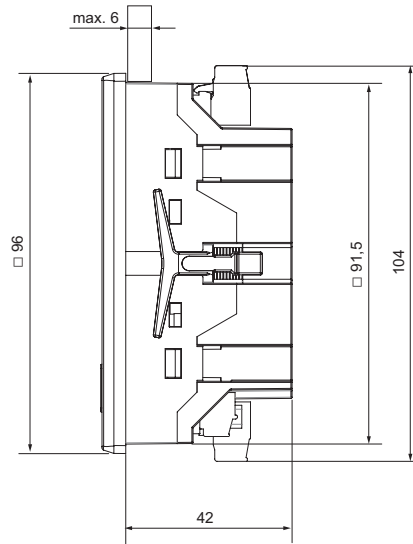

**View from below**

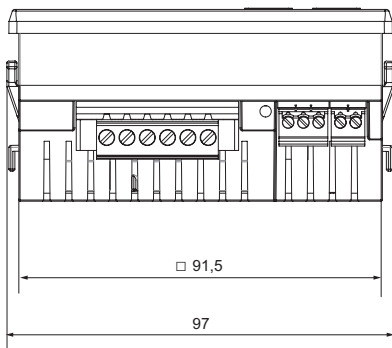

**Cut-out size**

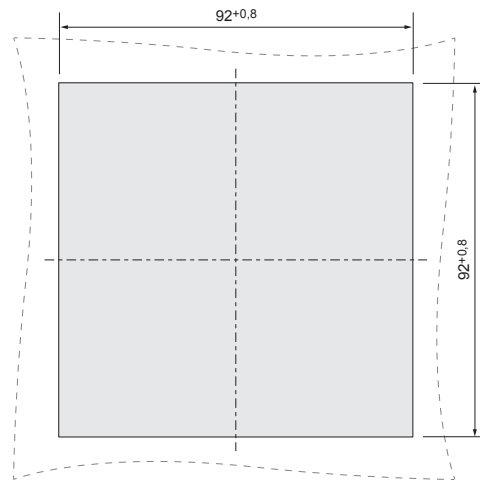

# ***Janitza***<sup>®</sup>

Janitza electronics GmbH  
Vor dem Polstück 6  
35633 Lahnau, Germany  
Tel.: +49 6441 - 9642-0  
e-mail: [info@janitza.com](mailto:info@janitza.com)  
[info@janitza.com](mailto:info@janitza.com) | [www.janitza.com](http://www.janitza.com)