

UMG 96 RM-E

Multifunctional power analyzer with Ethernet and RCM



- Communication**
- Modbus (RTU, TCP, Gateway)
 - TCP/IP
 - HTTP (configurable homepage)
 - FTP (file transfer)
 - SNMP
 - NTP (time synchronisation)
 - SMTP (email function)
 - DHCP
 - SNTP
 - TFTP
 - BACnet (optional)

- Interfaces**
- RS485
 - Ethernet

- Accuracy of measurement**
- Energy: Class 0.5S (... / 5 A)
 - Current: 0.2 %
 - Voltage: 0.2 %

- Power quality**
- Harmonics up to 40th harmonic
 - Rotary field components
 - Distortion factor THD-U / THD-I

- Networks**
- TN, TT, IT networks
 - 3 and 4-phase networks
 - Up to 4 single-phase networks

- Measured data memory**
- 256 MB Flash

- Temperature measurement**
- PT100, PT1000, KTY83, KTY84

- 2 digital outputs**
- Pulse output kWh / kvarh
 - Switch output
 - Threshold value output
 - Logic output
 - Remote via Modbus / Profibus

- 3 digital inputs/outputs**
- Usable as either inputs or outputs

- 2 analogue inputs**
- Analogue, temperature or residual current input (RCM)

- Power Grid Monitoring Software**
- Free GridVis® Essentials

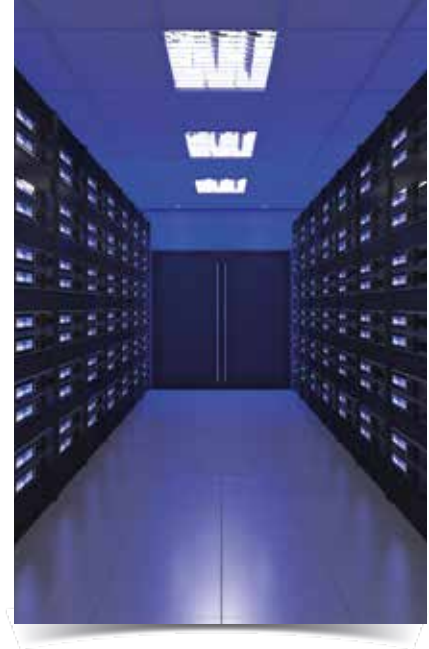

Areas of application



- Measurement, monitoring and checking of electrical characteristics in energy distribution systems
- Recording of load profiles in energy management systems (e.g. ISO 50001)
- Acquisition of the energy consumption for cost centre analysis
- Measured value transducer for building management systems or PLC (Modbus)
- Monitoring of power quality characteristics, e.g. harmonics up to 40th harmonic
- Residual current monitoring (RCM)

Main features

Universal meter

- Operating current monitoring for general electrical parameters
- High transparency through a multi-stage and scalable measurement system in the field of energy measurement
- Acquisition of events through continuous measurement with 200 ms high resolution



RCM device

- Continuous monitoring of residual currents (Residual Current Monitor, RCM)
- Alarming in case a preset threshold fault current reached
- Near-realtime reactions for triggering countermeasures
- Permanent RCM measurement for systems in permanent operation without the opportunity to switch off

Energy measurement device

- Continuous acquisition of the energy data and load profiles
- Essential both in relation to energy efficiency and for the safe design of power distribution systems



Harmonics analyser / event recorder

- Analysis of individual harmonics for current and voltage
- Prevention of production downtimes
- Significantly longer service life for equipment
- Rapid identification and analysis of power quality fluctuations by means of user-friendly tools (GridVis®)

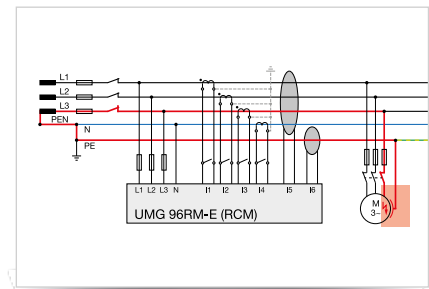

Fig.: UMG 96RM-E with residual current monitoring via measuring inputs I5 / I6

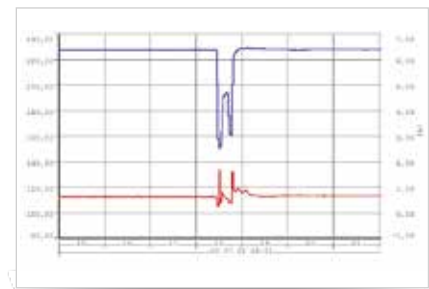

Fig.: Event logger: Voltage dip in the low voltage distribution system

7 Tariffs

Extensive selection of tariffs

- 7 tariffs each for effective energy (consumption, delivery and without backstop)
- 7 tariffs each for reactive energy (inductive, capacitive and without backstop)
- 7 tariffs for apparent energy
- L1, L2 and L3, for each phase

Highest possible degree of reliability

- Continuous leakage current measurement
- Historical data: Long-term monitoring of the residual current allows changes to be identified in good time, e.g. insulation faults
- Time characteristics: Recognition of time relationships
- Prevention of neutral conductor carryover
- RCM threshold values can be optimized for each individual case: Fixed, dynamic and stepped RCM threshold value
- Monitoring of the CGP (central ground point) and the sub-distribution panels

Analysis of fault current events

- Event list with time stamp and values
- Presentation of fault currents with characteristic and duration
- Reproduction of phase currents during the fault current surge
- Presentation of the phase voltages during the fault current surge

Analysis of the harmonic fault current components

- Frequencies of the fault currents (fault type)
- Current peaks of the individual frequency components in A and %
- Harmonics analysis up to 40th harmonic
- Maximum values with real-time bar display

Digital IOs

- Extensive configuration of IOs for intelligent integration, alarm and control tasks

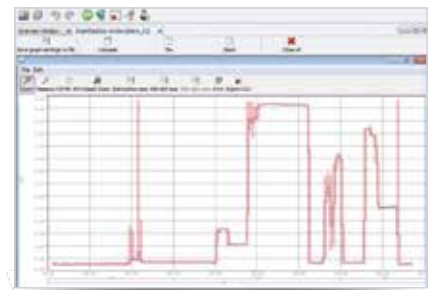

Fig.: Continuous leakage current measurement

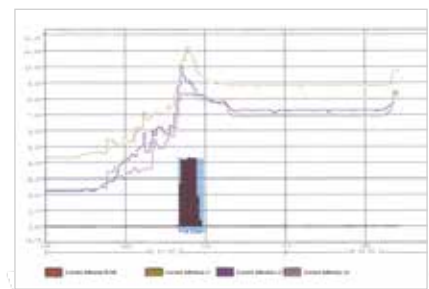

Fig.: Analysis of fault current events

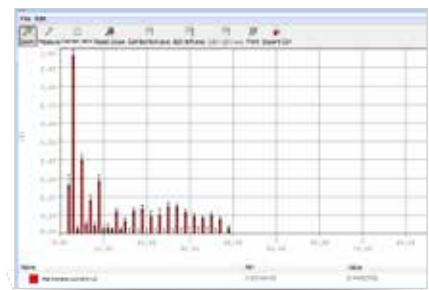

Fig.: Analysis of the harmonic fault current components



Ethernet (TCP/IP)- / Homepage- / Ethernet-Modbus gateway functionality

- Simple integration into the network
- More rapid and reliable data transfer
- Modern homepage
- World-wide access to measured values by means of standard web browsers via the device's inbuilt homepage
- Access to measurement data via various channels
- Reliable saving of measurement data possible over a very long periods of time in the 256 MByte measurement data memory
- Connection of Modbus slave devices via Ethernet-Modbus gateway



Fig.: Ethernet-Modbus gateway functionality



Measuring device homepage

- Webserver on the measuring device, i.e. device's own homepage
- Remote operation of the device display via the homepage
- Comprehensive measurement data incl. PQ
- Online data directly available via the homepage, historic data optional via the APP measured value monitor, 51.00.246

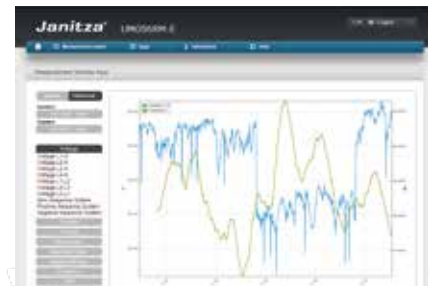
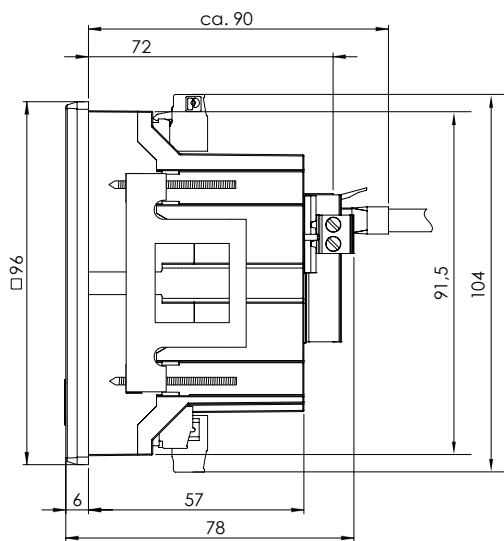

Fig.: Illustration of the online data via the device's inbuilt homepage



Dimension diagrams

All dimensions in mm



Side view

Cut out: 92^{+0,8} x 92^{+0,8} mm

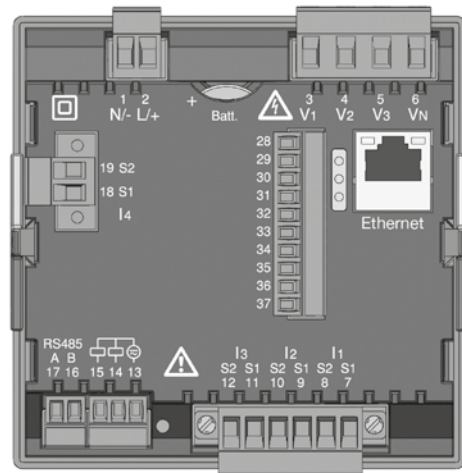

Rear view



Typical connection

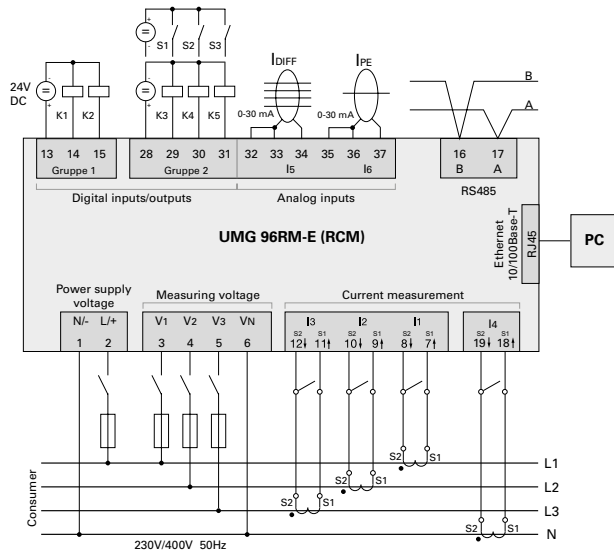

Fig.: Connection example with temperature and residual current measurement

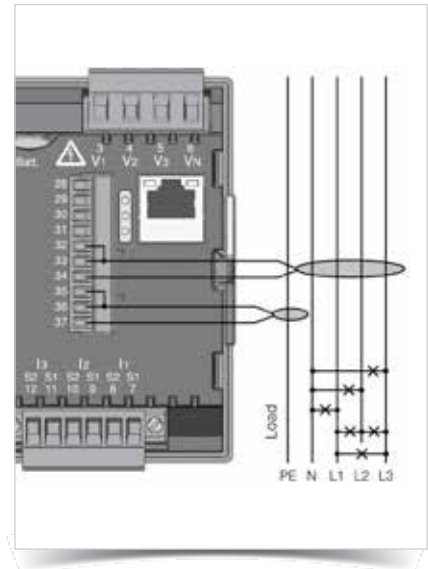

Fig.: Connection example residual current measurement and PE monitoring



Device overview and technical data

	UMG 96RM-E
Item no. (90–277 V AC / 90–250 V DC)	52.22.062
Item no. (24-90 V AC / 24-90 V DC)	52.22.063
BACnet communication	52.22.081

General	
Net weight (with attached connectors)	approx. 370 g (0.82 lb)
Package weight (incl. accessories)	approx. 950 g (2.09 lb)
Battery	Lithium battery CR2032, 3V (approval i.a.w. UL 1642)
Service life of backlight	40000 h (after this period of time the background lighting efficiency will reduce by approx. 50 %)

Transport and storage	
The following information applies to devices which are transported or stored in the original packaging.	
Free fall	1m
Temperature	K55 (-25° C to +70° C) (-13 °F ..to 158 °F)
Relative humidity	0 to 90% RH

Ambient conditions during operation	
The UMG 96RM is intended for weather-protected, stationary use. Protection class II in acc. with IEC 60536 (VDE 0106, Part 1).	
Operating temperature range	K55 (-10° C to +55° C) (14 °F ..to 131 °F)
Relative humidity	0 to 75% RH
Operating altitude	0 to 2000 m above sea level
Degree of pollution	2
Mounting position	vertical
Ventilation	forced ventilation is not required.
Protection against ingress of solid foreign bodies and water - Front - Rear - Front with seal	IP40 in acc. with EN60529 IP20 in acc. with EN60529 IP54 in acc. with EN60529

Supply voltage		
Option 230V	Nominal range	90 V - 277 V (50/60 Hz) or DC 90 V - 250 V; 300 V CAT III
	Power consumption	max. 7.5 VA / 4 W
Option 24V	Nominal range	24 V - 90 V AC / DC; 150 V CAT III
	Power consumption	max. 7.5 VA / 5 W
Operating range	±10% of nominal range	
Internal fuse, not replaceable	Type T1A / 250 V/277 V according to IEC 60127	
Recommended overcurrent protection device for line protection (certified under UL)	Option 230V: 6 - 16A Option 24V: 1 - 6A (Char. B)	

Recommendation for a maximum number of devices on a circuit breaker:

Option 230V: Circuit breaker B6A: max. 4 devices / Circuit breaker B16A: max. 11 devices

Option 24V : Circuit breaker B6A: max. 3 devices / Circuit breaker B16A: max. 9 devices

Digital outputs	
2 and 3 optional additional digital outputs, semiconductor relay, not short-circuit proof	
Switching voltage	Max. 33 V AC, 60 V DC
Switching current	max. 50 mAeff AC/DC
Response time	10/12 periods + 10 ms *
Pulse output (energy pulses)	max. 50 Hz

* Response time, e.g. at 50 Hz: 200 ms + 10 ms = 210 ms

Digital inputs	
3 optional additional digital outputs, semiconductor relay, not short-circuit proof	
Maximum counter frequency	20 Hz
Input signal present	18 V to 28 V DC (typical 4 mA)
Input signal not present	0 to 5 V DC, current less than 0.5 mA

Temperature measurement input	
2 optional inputs	
Update time	1 second
Connectable sensors	PT100, PT1000, KTY83, KTY84
Total burden (sensor + cable)	max. 4 kOhm

Sensor type	Temperature range	Resistor range	Measurement uncertainty
KTY83	-55° C ... +175° C (-67 °F ..to 347 °F)	500 Ohm to 2.6 kOhm	±1.5% rng
KTY84	-40° C ... +300° C (-40 °F ..to 572 °F)	350 Ohm to 2.6 kOhm	±1.5% rng
PT100	-99° C ... +500° C (-146.2 °F ..to 932 °F)	60 Ohm to 180 Ohm	±1.5% rng
PT1000	-99° C ... +500° C (-146.2 °F ..to 932 °F)	600 Ohm to 1.8 kOhm	±1.5% rng



Cable length (digital inputs / outputs, temperature measurement input)	
Up to 30 m	unshielded
More than 30 m	shielded

Serial interface	
RS485 to Modbus RTU/Slave	9.6 kbps, 19.2 kbps, 38.4 kbps, 57.6 kbps, 115.2 kbps
Stripping length	7 mm

Voltage measurement	
Three-phase 4-conductor systems with rated voltages up to	277 V/480 V ($\pm 10\%$)
Three-phase 3-conductor systems, unearthed, with rated voltages up to	IT 480V ($\pm 10\%$)
Overvoltage category	300 V CAT III
Measurement voltage surge	4 kV
Metering range L-N	0 ¹⁾ to 300 V _{rms} (max. overvoltage 520 V _{rms})
Metering range L-L	0 ¹⁾ to 520 V _{rms} (max. overvoltage 900 V _{rms})
Resolution	0.01 V
Crest factor	2.45 (related to the measurement range)
Impedance	3 M Ω /phase
Power consumption	approx. 0.1 VA
Sampling rate	21.33 kHz (50 Hz), 25.6 kHz (60 Hz) for each measurement channel
Frequency of the fundamental oscillation	45 Hz to 65 Hz
- Resolution	0.01 Hz

¹⁾ The UMG 96RM-E can only determine measured values if a voltage L1-N greater than 20 Veff (4-wire measurement) or a voltage L1-L2 greater than 34 Veff (3-wire measurement) is applied at the voltage measurement input V1.

Current measurement I1 - I4	
Rated current	5 A
Metering range	0 to 6 A _{rms}
Crest factor	1.98
Resolution	0.1 mA (display 0.01 A)
Overvoltage category	300 V CAT II
Measurement voltage surge	2 kV
Power consumption	approx. 0.2 VA (Ri = 5 m Ω)
Overload for 1 sec.	120 A (sinusoidal)
Sampling rate	20 kHz

Residual current monitoring I5 / I6	
Rated current	30 mA _{rms}
Metering range	0 to 40 mA _{rms}
Triggering current	50 μ A
Resolution	1 μ A
Crest factor	1.414 (related to 40 mA)
Burden	4 Ohm
Overload for 1 sec.	5 A
Sustained overload	1 A
Overload for 20 ms	50 A
Residual current monitoring	as per IEC/TR 60755 (2008-01), Type A  Type B 

Ethernet connection	
Connection	RJ45
Functions	Modbus gateway, embedded web server (HTTP)
Protocols	TCP/IP, DHCP-Client (BootP), Modbus/TCP (Port 502), ICMP (Ping), NTP, Modbus RTU over Ethernet (Port 8000), FTP, SNMP

Terminal connection capacity (supply voltage)	
Connectable conductors. Only one conductor can be connected per terminal!	
Single core, multi-core, fine-stranded	0.2 - 2.5 mm ² , AWG 26 - 12
Terminal pins, core end sheath	0.2 - 2.5 mm ²
Tightening torque	0.4 - 0.5 Nm (3.54 - 4.43 lbf in)
Stripping length	7 mm (0.2756 in)

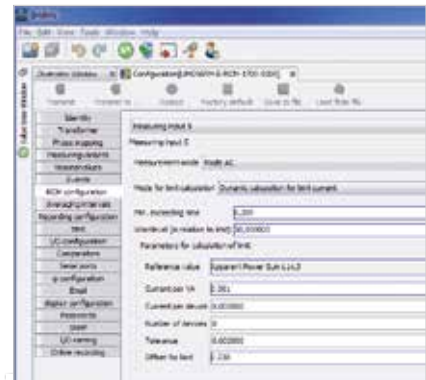

Fig.: RCM configuration, e.g. dynamic threshold value formation, for load-dependent threshold value adaptation



Fig.: Residual current transformer for the acquisition of residual currents. Wide range with different configurations and sizes allow use in almost all applications

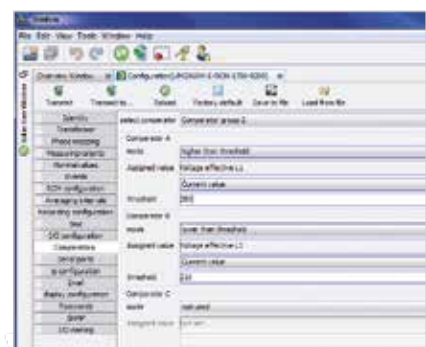

Fig.: GridVis® Power Grid Monitoring Software, configuration menu

Terminal connection capacity (voltage and current measurement)		
Connectable conductors. Only one conductor can be connected per terminal!		
	Current	Voltage
Single core, multi-core, fine-stranded	0.2 - 2.5 mm ² , AWG 26-12	0.08 - 4.0 mm ² , AWG 28-12
Terminal pins, core end sheath	0.2 - 2.5 mm ²	0.2 - 2.5 mm ²
Tightening torque	0,4 - 0,5 Nm (3.54 - 4.43 lbf in)	0,4 - 0,5 Nm (3.54 - 4.43 lbf in)
Stripping length	7 mm (0.2756 in)	7 mm (0.2756 in)

Terminal connection capacity (residual current and temperature measurement inputs and digital inputs/outputs)	
Rigid/flexible	0.14 - 1.5 mm ² , AWG 28-16
Flexible with core end sheath without plastic sleeve	0.20 - 1.5 mm ²
Flexible with core end sheath with plastic sleeve	0.20 - 1.5 mm ²
Tightening torque	0,20 - 0,25 Nm (1.77 - 2.21 lbf in)
Stripping length	7 mm (0.2756 in)

Terminal connection capacity (serial interface)	
Single core, multi-core, fine-stranded	0.20 - 1.5 mm ²
Terminal pins, core end sheath	0.20 - 1.5 mm ²
Tightening torque	0,20 - 0,25 Nm (1.77 - 2.21 lbf in)
Stripping length	7 mm (0.2756 in)

Firmware	
Firmware update	Please observe the operating instructions

Remark: For detailed technical information, please refer to the operation manual and Modbus address list.

